

# ID-WEEDER

EN

*Electrohydraulic in-row weeder  
adaptable to all frames or cultivators*



VITI

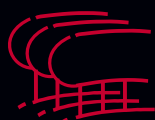

SETO



ARBO



**DAVID**  
SMART FARMING SOLUTIONS

SERIE

# ID-WEEDER



**Electrohydraulic in-row weeder adaptable to all frames or cultivators** for mechanical weeding or tillage inside rows (mainly vineyards and fruit trees).

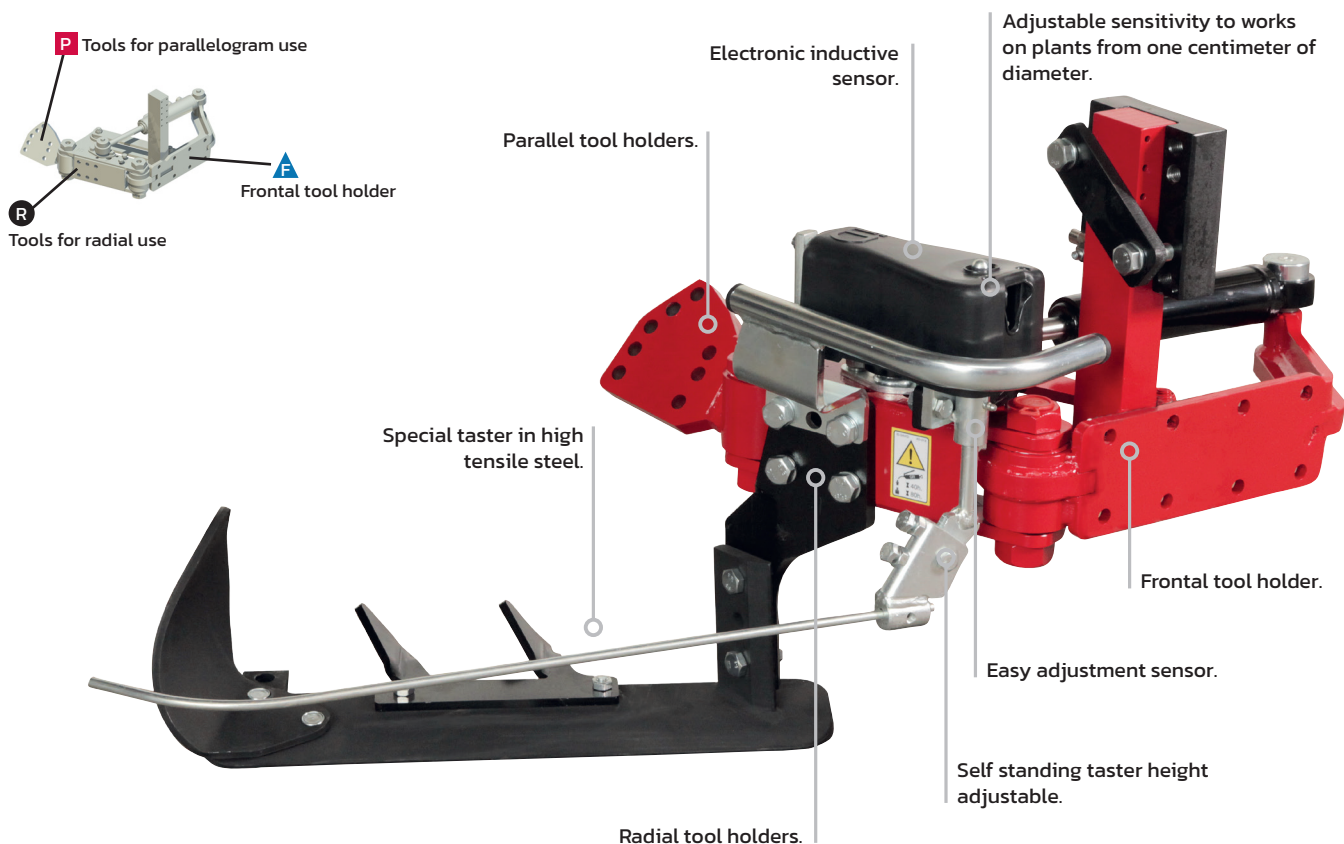

PICTURE MODEL:  
IA-D + VO-D

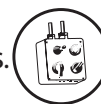

## Versatility

- The widest range of products and accessories on the market. A custom configuration to suit your needs.
- The ID-CONTROL joystick allows to control all the machines manufactured by ID David and equipped with the ID-PLUS or ID-MICRO technology.
- Different tools that allow both surface and tillage works up to 20 cm deep.

## Exclusivity

- The exclusive undervine weeder that combines the "parallelogram-radial" movement.
- Faster, safer and endowed with unmatched versatility thanks to its triple tool holder.
- The adjustable and progressive electronic sensor allows a safe working under plants from 1 cm diameter, the parallelogram moves at right time to save the plant.

## Effectiveness

- Time is valuable, it is possible to work up to 12 km/h with a standard soil conditions.
- The easy adjusting of hydraulic pressure of the in row weeder assured a perfect work in any type of soil.

## Reliability

- Components and materials of high quality from certified manufacturers.
- Heavy duty frame and robotic welding.
- Experience on manufacturing of electrohydraulic in-row weeder since 1974.

## Safety

- As standard all models are fitted with an exclusive safety locking system in case of faults.
- Enables route deviations up to 30 cm in the plantation rows.
- Our equipment incorporates easy, comfortable and safe tool replacement systems.

## Sustainability

- Ecological alternative to the use of herbicides
- Our painting is lead-free and without toxic pigments.
- Improves the structure and porosity of the soil.

## Standard Equipment

- Anti-shock sensor protector.
- Box + flange for frame or cultivator assembly.
- Hydraulic pressure regulator.
- Tool kit for sensor regulation.
- Arm "D" and Plough blade to weed manufactured in boron steel.
- Special testrod sensor in high tensile steel.
- Security system under damages.
- Self standing taster height adjustable.
- Electronic inductive sensor.
- Connection valve direct to tractor.

## Remote control type

### ID-PLUS











- Includes ID-CONTROL multifunction joystick.
- Includes ON-OFF of powered tools.
- Includes an electronic microcontroller: allows software updates at any time.
- Up to 5 additional electro-hydraulic functions.
- Includes a modular electro-hydraulic system: it allows to increase the number of electro-hydraulic functions.

### ID-MICRO

- ! NOT included the ID-CONTROL multifunction joystick.
- Only for customers who already have the ID-CONTROL multifunction joystick.
- Includes ON-OFF of powered tools.
- Includes an electronic microcontroller: allows software updates at any time.
- Up to 5 additional electro-hydraulic functions.
- Includes a modular electro-hydraulic system: it allows to increase the number of electro-hydraulic functions.



### ID-BASIC

- Includes an electric control box.
- Max. 1 additional electro-hydraulic function to choose between: PI-002 / PI-004 / IH-EC
- ! NOT allowed any updates of electro-hydraulic functions.

		ID-PLUS	ID-MICRO	ID-BASIC	
					
<b>ID-WEEDER</b>	cm	REF.	REF.	REF.	
<b>COMPACT</b>		49	IAC-1-D	IAC-2-D	IAC-3-D
		49	IAC-1-P	IAC-2-P	IAC-3-P
<b>STANDARD</b>		55	IA-1-D	IA-2-D	IA-3-D
		55	IA-1-P	IA-2-P	IA-3-P
<b>LARGE</b>		65	IAL-1-D	IAL-2-D	IAL-3-D
		65	IAL-1-P	IAL-2-P	IAL-3-P



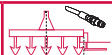

## Technical details

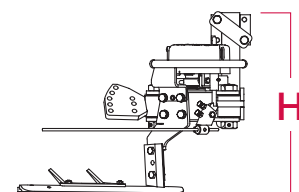
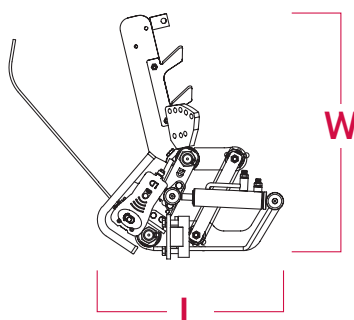
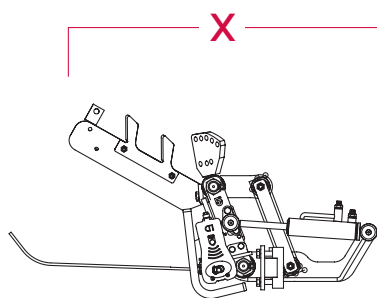
		X				L	W	H
ID-WEEDER	REF.	m	kg	m	HP	m	m	m
<b>COMPACT</b>	IAC-D	0,75	70	≤1	30	0,45	0,65	0,60
	IAC-P	0,75	135	≤1	35	0,45	0,65	0,60
<b>STANDARD</b>	IA-D	1,00	70	≤1	30	0,60	0,75	0,60
	IA-P	1,00	135	≤1	35	0,60	0,75	0,60
<b>LARGE</b>	IAL-D	1,10	70	≤2	30	0,60	0,85	0,60
	IAL-P	1,10	135	≤2	35	0,60	0,85	0,60





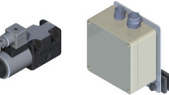

## Pre-installations and updates













### Accessories and Options

	DESCRIPTION	OBSERVATIONS	REF.
	Pre-installation in-row weeder left side/electrohydraulic system		PI-001
	Pre-installation solenoid valve	1 extra function double acting on/off motorized tools	PI-002 PI-004
		for ID-BASIC	
	Quick connection kit for power tools		KC-001

## Undervine weeders



### Accessories and Options



	DESCRIPTION	OBSERVATIONS	REF.
	Hydraulic power PRO unit 22L with pump 27L	Adaptable to frame	 CPRO-0
	Standard oil cooler	Adaptable to PRO hydraulic power plant	Intake 12V A15-01-PRO
	Pressure filter kit + oil cooler	Tractor plugs connection	Intake 12V KFP-02

	DESCRIPTION	OBSERVATIONS	REF.	
	<b>Hydraulic side slope correction for in-row weeders</b>  Increases working width of 10 cm Inclination: + 21°, -10°	Directly to the tractor  Electric cabine	Unit   Unit	IH-DT  IH-EC
	<b>Grass bend down system</b>		Right  Pair	STH-D  STH-P
	<b>Ultrasensible kit for sensitive sensor</b>	Ideal vineyards ≤ 1 cm	Unit	KU-1
	<b>Reinforced in row weeder cylinder for hard soil</b>	Replaces standard cylinder. Recommended oil cooler.	Unit	CIA-R
	<b>Distance Control with cable</b>	for ID-PLUS / ID-MICRO  for ID-BASIC	Right  Pair  Right  Pair	MD1-D  MD1-P  MD2-D  MD2-P
	<b>Electrohydraulic kit for quick-connection (connection-disconnection)</b>	In row weeder connection-disconnection Not available for ID-BASIC	Right  Pair	KER-IA-D  KER-IA-P
	<b>Additional extension (female-female)</b>		120 mm  200 mm	SE1-HH  SE2-HH
	<b>Additional extension of 120mm (male-female)</b>			SE-MH
	<b>Adjustable row cleaner disc 11" (smooth disc)</b>	Adaptable to in-row weeder	Right  Pair	BPI-D  BPI-P
	<b>Adjustable row cleaner disc 13" (notched disc)</b>	Adaptable to in-row weeder	Right  Pair	BPID-D  BPID-P
	<b>Storage foot and frame equipped with wheels</b>		Right	PAIR-D

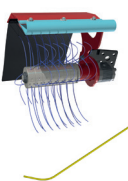
## Undervine weeders

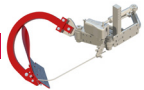

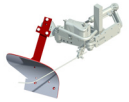

### Tools for PARALLELOGRAM USE P

	DESCRIPTION	OBSERVATIONS	REF.	
	<b>Shoot remover kit + Sensor rod + String spool</b>  250 mm working width	IA-C   IA  IAL	Right	DBR25-1-D  DBR25-2-D
	*Recommended oil cooler Available only for vineyards with at least 40 cm free to the ground or to any obstacle	IA-C   IA  IAL	Pair	DBR25-1-P  DBR25-2-P
	<b>Arm B + fixed ploughshare + Sensor rod kit</b>	310x480x400mm	Right  Pair	BB-VFD  BB-VFP
	<b>Arm C + adjustable ploughshare + sensor rod kit</b>	410x540x430mm	Right  Pair	BC-VRD  BC-VRP

	DESCRIPTION	OBSERVATIONS	REF.
		Right	BE-VFD
		Pair	BE-VFP
	Retractable extra cleaner blade with spring for ploughshare	Right	EM-D
		Pair	EM-P

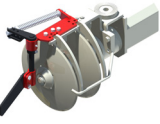
### Undervine weeders Tools for **RADIAL USE**

		Standard included	Right	BD-CPD
			Pair	BD-CPP
		Right	Cut 49 cm	RCI49D
			Standard 55 cm	RCI55D
			Long 65 cm	RCI65D
		Pair	Cut 49 cm	RCI49P
			Standard 55 cm	RCI55P
			Long 65 cm	RCI65P
		Right		RCHD55D
			Standard 55 cm	
		Pair		RCHD55P
	Retractable extra cleaner blade "V" for blade		Right	EV-D
			Pair	EV-P
	Blade shovel		Right	VO-D
			Pair	VO-P
		IA-C   IA	Right	MAD25-1-D
		IAL		MAD25-2-D
		IA-C   IA	Pair	MAD25-1-P
		IAL		MAD25-2-P
	Recommended oil cooler and reinforced cylinder			
		IA-C   IA	Right	MAD35-1-D
		IAL		MAD35-2-D
		IA-C   IA	Pair	MAD35-1-P
		IAL		MAD35-2-P
	Recommended oil cooler and reinforced cylinder			

	DESCRIPTION	OBSERVATIONS	REF.
	Retractable extra cleaner blade for mini harrow disc	Right	EMD-D
		Pair	EMD-P
R	Kit Rotary hoe Ø300mm + sensor rod	IA-C   IA	RA30-1-D
		IAL	RA30-2-D
	*Possibility of simultaneous use with weeding blade (not included) Recommended oil cooler + reinforced cylinder	IA-C   IA	RA30-1-P
		IAL	RA30-2-P
R	Kit Rotary hoe Ø400mm + Sensor rod	IA-C   IA	RA40-1-D
		IAL	RA40-2-D
	*Possibility of simultaneous use with weeding blade (not included) Recommended oil cooler + reinforced cylinder	IA-C   IA	RA40-1-P
		IAL	RA40-2-P
R	Kit Rotary hoe Ø500mm + Sensor rod	IA-C   IA	RA50-1-D
		IAL	RA50-2-D
	Recommended oil cooler and reinforced cylinder	IA-C   IA	RA50-1-P
		IAL	RA50-2-P
R	Kit string mower Ø400mm + Sensor rod + String reel	IA-C   IA	GS40H-1-D
		IAL	GS40H-2-D
	Recommended oil cooler and reinforced cylinder	IA-C   IA	GS40H-1-P
		IAL	GS40H-2-P
R	Kit string mower Ø500mm + Sensor rod + String reel	IA-C   IA	GS50H-1-D
		IAL	GS50H-2-D
	Recommended oil cooler and reinforced cylinder	IA-C   IA	GS50H-1-P
		IAL	GS50H-2-P
R	Kit string mower Ø600mm + Sensor rod + String reel	IA-C   IA	GS60H-1-D
		IAL	GS60H-2-D
	Recommended oil cooler and reinforced cylinder	IA-C   IA	GS60H-1-P
		IAL	GS60H-2-P
	Kit for modification of string mower with boron steel blades	Only available for new machine	Right
			Pair
	Square string spool	for mower	45 m
	Nylon string blue spool	for brush head	90 m
R	Herbicide application head	Ø500	Right
			Pair
	Packaging	Basic	AH50D
		Airfreight- oceanfreight	AH50P
			EMB-1
			EMB-2

**Ideal products and services that inspire trust, quality, experience and excellence**

Specialized and customized agricultural machines with an attractive design and increasing digitalizations. Our products are oriented towards a biological, environment-friendly and precision farming.



**INDUSTRIAS DAVID S.L.U.**  
C/ Médico Miguel Lucas s/n  
CP: 30510, Yecla, Murcia-Spain  
Tel.: +34 968 718 119  
[info@id-david.com](mailto:info@id-david.com)

**Connect with us.**  
[instagram.com/iddavid\\_official](https://www.instagram.com/iddavid_official)  
[twitter.com/IDdavidslu](https://twitter.com/IDdavidslu)  
[facebook.com/industriasdavid](https://www.facebook.com/industriasdavid)  
[linkedin.com/company/id-david](https://www.linkedin.com/company/id-david)  
[youtube.com/industriasdavid](https://www.youtube.com/industriasdavid)

[www.id-david.com](http://www.id-david.com)

