

ID-ROLL

EN

Reversible frame with fingerhoe and star roller



SERIE

ID-ROLL



Reversible frame with fingerhoe and star roller. Design for a perfect elimination of small weeds between plants formed in rows.

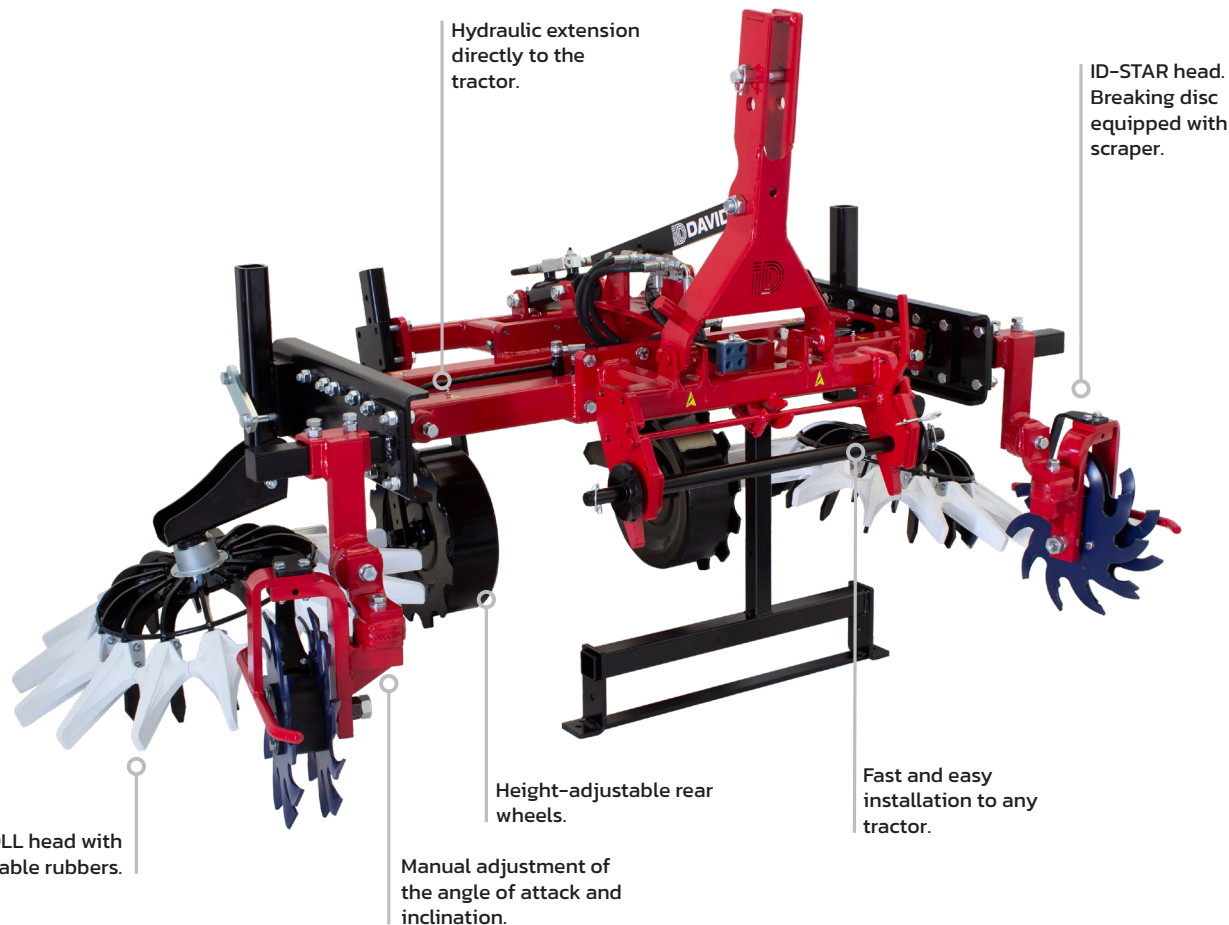

Hydraulic extension directly to the tractor.

ID-STAR head. Breaking disc equipped with scraper.

ID-ROLL head with replaceable rubbers.

Height-adjustable rear wheels.

Fast and easy installation to any tractor.

Manual adjustment of the angle of attack and inclination.

PICTURE MODEL:
ROLL-M-P + CRA-DT



Versatility

- Complete range. A configuration according to your needs.

Exclusivity

- Rubber fingers can be replaced individually. Different formats are available depending on the soil type.

Effectiveness

- Working speeds up to 20 km/h.
- Sustainable consumption: Equipment designed to be up-to-date and have a long service life.

Reliability

- Heavy duty frame and robotic welding.
- Components and materials of high quality from certified manufacturers.
- Head built in Hardox.

Safety





- All models are designed for a safe, simple and intuitive use.
- Maximum protection in plants from 2 years old.

Sustainability

- Ecological alternative to the use of herbicides.
- Our painting is lead-free and without toxic pigments.
- Improves the structure and porosity of the soil.

Standard Equipment

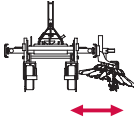
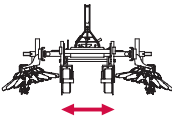

- Reversible chassis for use in front and rear 3rd point.
- Hydraulic width adjusting to the tractor.
- Adjustable pair of metal wheels in height and width.
- Storage foot.
- Quick coupling.
- ID-ROLL equipped with replaceable tips.
- ID-STAR 2 or 3 rollbreakers discs (depending on model).

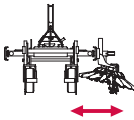
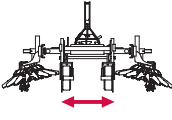
				
ID-ROLL		m	REF.	REF.
	RIGHT	$\geq 2,00$	ROLL-S2-D	ROLL-S3-D
		$\geq 2,40$	ROLL-M2-D	ROLL-M3-D
		$\geq 2,80$	ROLL-L2-D	ROLL-L3-D
		PAIR	2,00-2,50	ROLL-S2-P
		2,40-3,10	ROLL-M2-P	ROLL-M3-P
		3,04-4,04	ROLL-L2-P	ROLL-L3-P

	RIGHT	$\geq 1,80$	ROLL-6-S2-D	ROLL-6-S3-D
		$\geq 2,20$	ROLL-6-M2-D	ROLL-6-M3-D
		$\geq 2,60$	ROLL-6-L2-D	ROLL-6-L3-D
		PAIR	1,80-2,30	ROLL-6-S2-P
		2,20-2,90	ROLL-6-M2-P	ROLL-6-M3-P
		2,60-3,60	ROLL-6-L2-P	ROLL-6-L3-P



Technical details

ID-ROLL	REF.	X			L	W	H	
		m	kg	HP	m	m	m	
	RIGHT	ROLL-S-D	≥ 2,00	290	30	1,40	1,30	1,35
		ROLL-M-D	≥ 2,40	300	35	1,40	1,70	1,35
		ROLL-L-D	≥ 2,80	310	40	1,40	2,10	1,35
PAIR	ROLL-S-P	2,00-2,50	350	35	1,40	1,60	1,35	
	ROLL-M-P	2,40-3,10	365	40	1,40	2,00	1,35	
	ROLL-L-P	3,04-4,04	380	45	1,40	2,40	1,35	

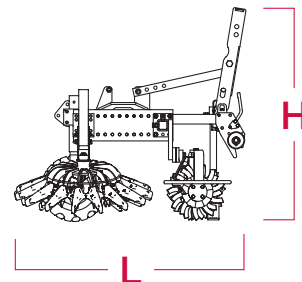
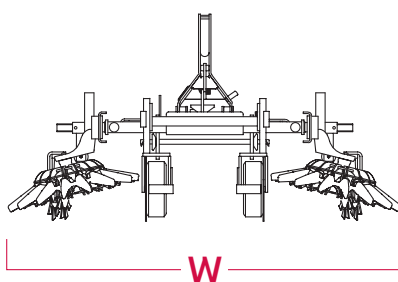
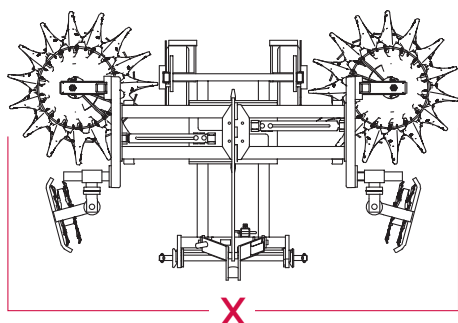

	RIGHT	ROLL-6S-D	≥ 1,80	260	30	1,20	1,30	1,35
		ROLL-6M-D	≥ 2,20	270	35	1,20	1,70	1,35
		ROLL-6L-D	≥ 2,60	280	40	1,20	2,10	1,35
PAIR	ROLL-6S-P	1,80-2,30	320	35	1,20	1,60	1,35	
	ROLL-6M-P	2,20-2,90	335	40	1,20	2,00	1,35	
	ROLL-6L-P	2,60-3,60	350	45	1,20	2,65	1,35	



Tractor mounting

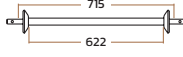

Drawbar

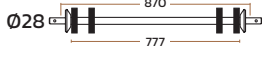



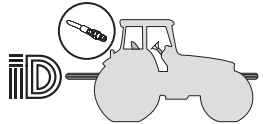
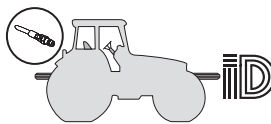
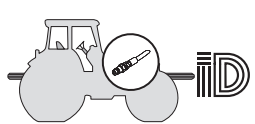





ID-ROLL	S Standard • Optional (Replace standard)	Ø22 	Ø28 	Ø28 
		REF. BE-2271	STANDARD	REF. BE-2887
ROLL-S	•	•	S	•
ROLL-M	•	•	S	•
ROLL-L	•	•	S	•

Tractor connection and assembling

		
STANDARD	REF. CMT-10	REF. CMT-5

Chassis

Accessories and Options

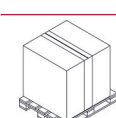
	DESCRIPTION		OBSERVATIONS	REF.
	Hydraulic adjustment of working height		Directly to the tractor New equipment	CRA-DT-1
	Three-point with tilting system <small>*Replace the standard one (Inclination: +10°, -10°)</small>		New equipment	TSB-01
	Hydraulic inclination ID-ROLL <small>*Increases working width of 10 cm Inclination: + 21°, -10°</small>		Directly to the tractor Unit	IH-DT
	ID-STAR 2 discs rotary star tiller			ID-ST2-D
	ID-STAR 3 discs rotary star tiller	Right		ID-ST3-D
	Extra price ID-STAR (3rd disc)			ID-ST23-D
	ID-STAR 2 discs rotary star tiller			ID-ST2-P
	ID-STAR 3 discs rotary star tiller	Pair		ID-ST3-P
	Extra price ID-STAR (3rd disc)			ID-ST23-P
	Over full plate extension		120 mm 200 mm	SEC-12 SEC-20
		2 mechanical disc harrow		Right
2 mechanical disc harrow			Working with a max. width of 400mm Pair	ADCV2P
	3 mechanical disc harrow		Right	ADCV3D
	3 mechanical disc harrow		Working with a max. width of 550mm Pair	ADCV3P
	Kit ID-ROLL Ø600	Right		KCAB-R6-D
	Kit ID-ROLL Ø850			KCAB-R8-D
	Kit ID-ROLL Ø600	Pair		KCAB-R6-P
	Kit ID-ROLL Ø850			KCAB-R8-P
	Packaging		Basic	EMB-1
			Airfreight- oceanfreight	EMB-3

Ideal products and services that inspire trust, quality, experience and excellence

Specialized and customized agricultural machines with an attractive design and increasing digitalizations. Our products are oriented towards a biological, environment-friendly and precision farming.



INDUSTRIAS DAVID S.L.U.
C/ Médico Miguel Lucas s/n
CP: 30510, Yecla, Murcia-Spain
Tel.: +34 968 718 119
info@id-david.com

Connect with us.
[instagram.com/iddavid_official](https://www.instagram.com/iddavid_official)
twitter.com/IDdavidslu
[facebook.com/industriasdavid](https://www.facebook.com/industriasdavid)
[linkedin.com/company/id-david](https://www.linkedin.com/company/id-david)
[youtube.com/industriasdavid](https://www.youtube.com/industriasdavid)

www.id-david.com

