

ID-NAMIC

EN

Reversible and extendable frame with undervine weeder to 3P hitching

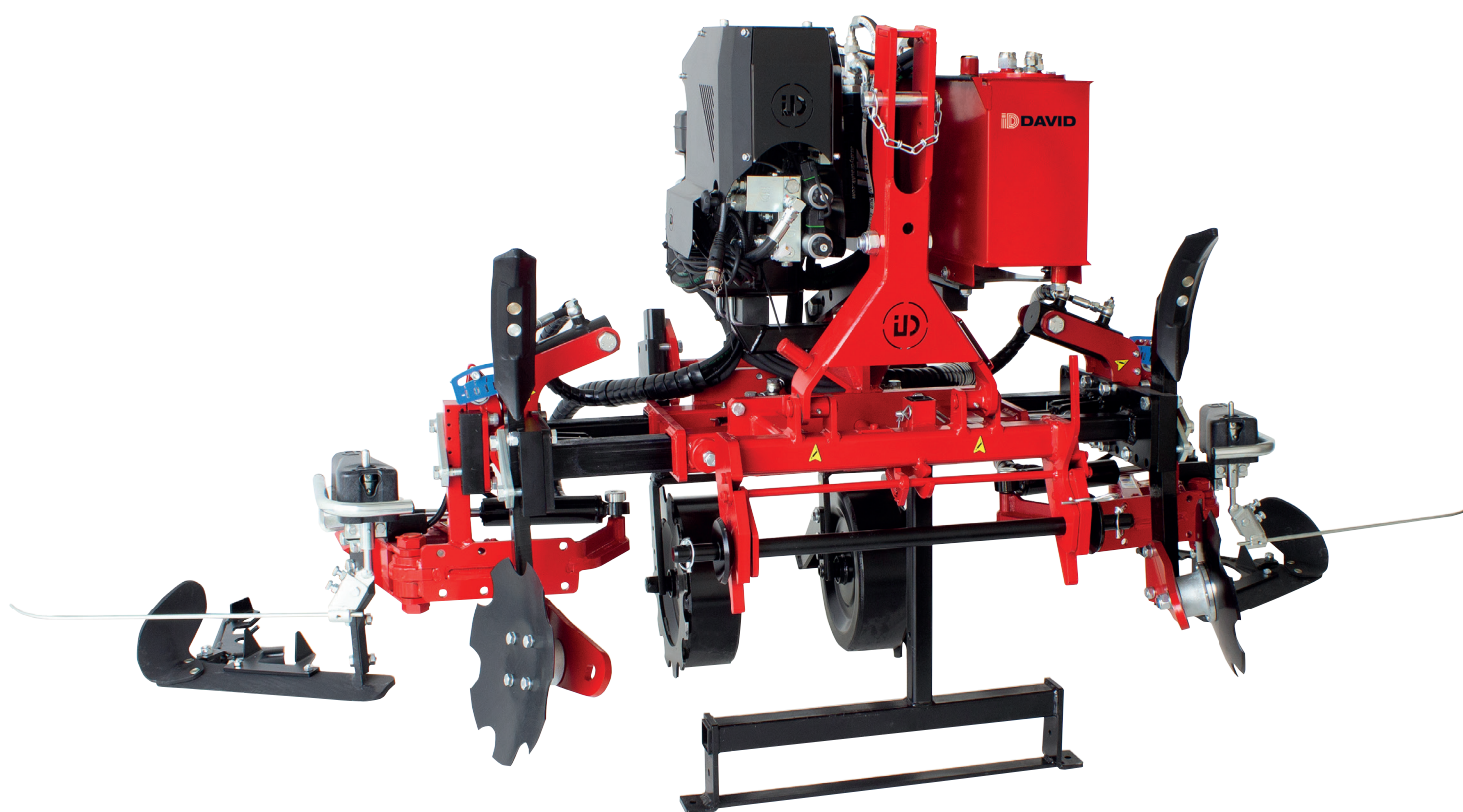

VITI



SETO



ARBO



DAVID
SMART FARMING SOLUTIONS

SERIE

ID-NAMIC



Reversible and extendable frame with undervine weeder to 3P hitching, perfect to tillage and weeding between plants rows.

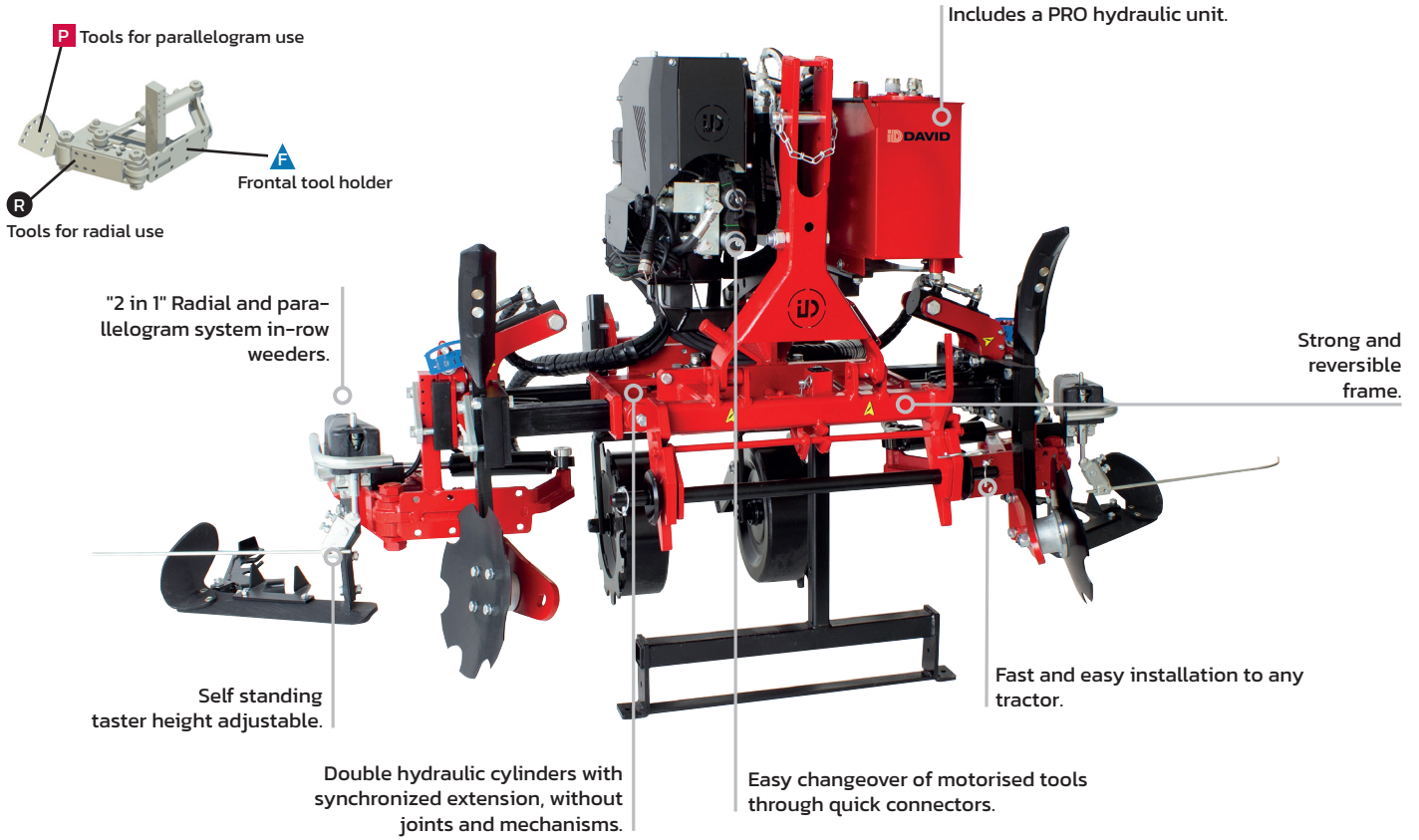

PICTURE MODEL:

CR-S-P + IH-EC + VO-P + EV-P + BB001P

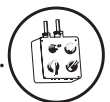

Versatility

- The widest range of products and accessories on the market. A custom configuration to suit your needs.
- Different tools that allow both surface and tillage works up to 20 cm deep.
- The ID-CONTROL joystick allows to control all the machines manufactured by ID David and equipped with the ID-PLUS or ID-MICRO technology.

Reliability

- Components and materials of high quality from certified manufacturers.
- Heavy duty frame and robotic welding.
- Experience in the manufacture of electrohydraulic undervine weeders since 1974.
- Great visibility of the rows.

Exclusivity

- The exclusive undervine weeder that combines the "parallelogram-radial" movement.
- Faster, safer and endowed with unmatched versatility thanks to its triple tool holder.
- Opportunity to work between plants starting from 1 cm diameter thanks to our adjustable and progressive electronic sensor, the arm is moving at the right time to save the plant.

Safety

- As standard all models are fitted with an exclusive safety locking system in case of faults.
- Enables route deviations up to 30 cm in the plantation rows.
- Our equipment incorporates easy, comfortable and safe tool replacement systems.

Effectiveness

- Time is valuable, it is possible to work up to 12 km/h with a standard soil conditions.
- The easy adjusting of hydraulic pressure of the in row weeder assured a perfect work in any type of soil.

Sustainability

- Ecological alternative to the use of herbicides.
- The low power required allows the use of small tractors with a lower carbon footprint.
- Improves the structure and porosity of the soil.

Standard Equipment

- Includes a PRO hydraulic unit.
- Anti-shock sensor protector.
- Reversible chassis for use in front and rear 3rd point.
- Hydraulic pressure regulator.
- Electro hydraulic in row weeder.
- Hydraulic width adjusting to the tractor.
- Tool kit for sensor regulation.
- Arm "D" and blade manufactured in boron steel.
- Quick coupling kit for power tools.
- Special rod sensor in high tensile steel.
- Pair of metallic notched wheels width and height adjustable.
- Storage foot.
- Quick coupling.
- Smooth wheels mounted on the front of the frame (CR-XS and CR-XXS models).
- Wheels assembly on the extension model CR-MAX.

Remote control type

ID-PLUS

- Includes ID-CONTROL multifunction joystick.
- Includes ON-OFF of powered tools.
- Includes an electronic microcontroller: allows software updates at any time.
- Up to 5 additional electro-hydraulic functions.
- Includes a modular electro-hydraulic system: it allows to increase the number of electro-hydraulic functions.

ID-MICRO







- ! NOT included the ID-CONTROL multifunction joystick.
- Only for customers who already have the ID-CONTROL multifunction joystick.
- Includes ON-OFF of powered tools.
- Includes an electronic microcontroller: allows software updates at any time.
- Up to 5 additional electro-hydraulic functions.
- Includes a modular electro-hydraulic system: it allows to increase the number of electro-hydraulic functions.

ID-BASIC

- Includes an electric control box.
- Max. 1 additional electro-hydraulic function to choose between: PI-002 / PI-004 / EH-EC / CRA-EC / IH-EC
- ! NOT allowed any updates of electro-hydraulic functions.

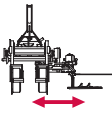
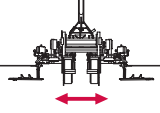

ID-PLUS DUAL

- Includes ID-CONTROL multifunction joystick.
- Includes ON-OFF of powered tools.
- Includes cooler and double pump.
- Includes an electronic microcontroller: allows software updates at any time.
- Up to 4 additional electro-hydraulic functions.
- Includes a modular electro-hydraulic system: it allows to increase the number of electro-hydraulic functions.

						
ID-NAMIC	cm	m	REF.	REF.	REF.	REF.
1 IN ROW WEEDER 	49	≥ 1,50	CR-XS-1-D	CR-XS-2-D	CR-XS-3-D	CR-XS-4-D
	55	≥ 1,85	CR-S-1-D	CR-S-2-D	CR-S-3-D	CR-S-4-D
	55	≥ 2,45	CR-M-1-D	CR-M-2-D	CR-M-3-D	CR-M-4-D
	65	≥ 2,90	CR-L-1-D	CR-L-2-D	CR-L-3-D	CR-L-4-D
2 IN ROW WEEDER 	49	1,35-1,70	CR-XXS-1-P	CR-XXS-2-P	CR-XXS-3-P	CR-XXS-4-P
	49	1,50-2,05	CR-XS-1-P	CR-XS-2-P	CR-XS-3-P	CR-XS-4-P
	55	1,85-2,60	CR-S-1-P	CR-S-2-P	CR-S-3-P	CR-S-4-P
	55	2,45-3,20	CR-M-1-P	CR-M-2-P	CR-M-3-P	CR-M-4-P
	65	2,90-4,00	CR-L-1-P	CR-L-2-P	CR-L-3-P	CR-L-4-P
	65	3,50-5,00	CR-MAX-1-P	CR-MAX-2-P	CR-MAX-3-P	CR-MAX-4-P



Technical details

		X			L	W	H
ID-NAMIC	REF.	m	kg	HP	m	m	m
1 IN ROW WEEDER	CR-XS-D	≥ 1,50	300	30	1,00	0,90	1,30
	CR-S-D	≥ 1,85	320	35	1,30	1,05	1,30
	CR-M-D	≥ 2,45	400	40	1,15	1,60	1,30
	CR-L-D	≥ 2,90	410	45	1,15	1,90	1,30
2 IN ROW WEEDER	CR-XXS-P	1,35-1,70	350	35	1,70	0,80	1,30
	CR-XS-P	1,50-2,05	350	35	1,00	1,00	1,30
	CR-S-P	1,85-2,60	370	40	1,30	1,35	1,30
	CR-M-P	2,45-3,20	450	45	1,15	1,90	1,30
	CR-L-P	2,90-4,00	460	50	1,15	2,20	1,30
	CR-MAX-P	3,50-5,00	480	50	1,15	2,85	1,30

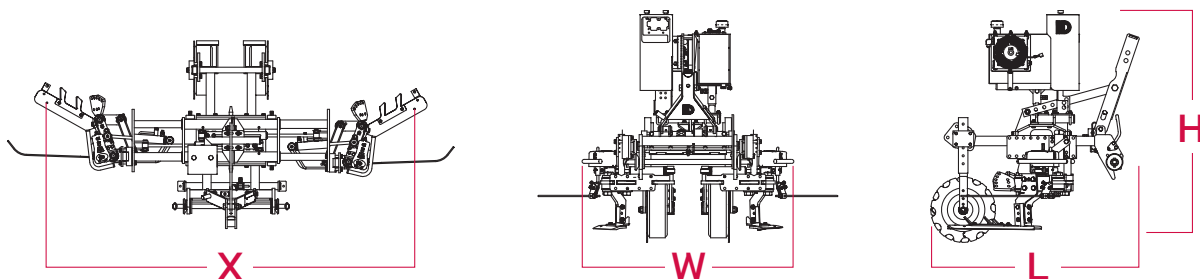







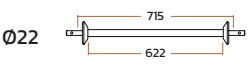
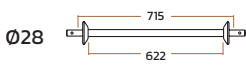
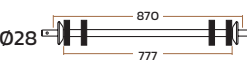

Tractor mounting

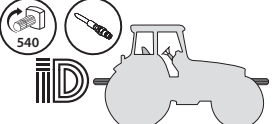

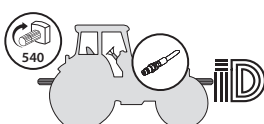

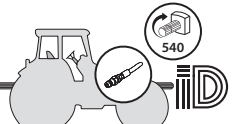
Drawbar

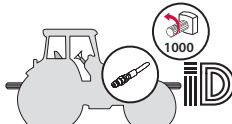
CR	 REF. BE-2271	 STANDARD	 REF. BE-2887
		•	S





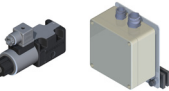

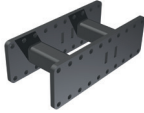

Tractor connection and assembling

			
STANDARD	REF. CMT-11	REF. CMT-6	REF. CMT-12
			
REF. CMT-7	REF. CMT-14	REF. CMT-9	REF. CMT-13

Pre-installations and updates Accessories and Options





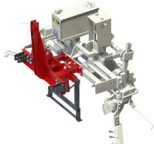





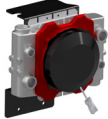



	DESCRIPTION	OBSERVATIONS	REF.
	Pre-installation in-row weeder left side/electrohydraulic system	Including extension and cylinder	PI-011
	Pre-installation solenoid valve	1 extra function double acting for ID-BASIC	PI-002
		on/off motorized tools	PI-004
	Upgrade kit for tools quick coupling		KC-002







Chassis Accessories and Options

	DESCRIPTION	OBSERVATIONS	REF.
	Over full plate extension	*Not available for XXS and XS	SEC-12
	Solenoid valve for hydraulic extension Integrated in control box		EH-EC
	Smooth Wheels assembly on the extension	Replace standard wheel frame Only for M & L models	MRE-1
	Pivoting smooth wheels assembly on the extension	To assembly on the front or with sandy soil. Not compatible with shank F. Not compatible with shank elastomer. Replace the standard wheel frame.	MREG-1
	Pair of rear pneumatic wheels	Replaces the metal wheels Adjustable in height	RNT-P
	Hydraulic adjustment of working height	Direct to tractor, it replace the standard wheels frame 	CRA-DT-1
	Incompatible with wheels mounted on extensions	Electric to replace the standard wheels frame	CRA-EC
	Three-point with tilting system	New machine replaces standard hitch frame	TSB-01
	*Replace the standard one (Inclination: +10° , -10°)	Second hand equipment	TSB-02

Undervine weeders







Accessories and Options

📷	DESCRIPTION	OBSERVATIONS		REF.
	Standard oil cooler	Adaptable to PRO hydraulic power plant	Intake 12V	A15-01-PRO
	Pressure filter kit + oil cooler	Replaces hydraulic power plant . Not available for ID-PLUS DUAL.	Intake 12V Tractor plugs connection.	 KFP-03
	Hydraulic side slope correction for in-row weeders	Directly to the tractor	Unit	 IH-DT
	*Increases working width of 10 cm Inclination: + 21°, -10°	Electric cabine	Unit	IH-EC
	Grass bend down system		Right	STH-D
			Pair	STH-P
	Ultrasensible kit for sensitive sensor	Ideal vineyards ≤ 1 cm	Unit	KU-1
	Reinforced in row weeder cylinder for hard soil	Replaces standard cylinder. Recommended oil cooler.	Unit	CIA-R
	Distance Control with cable	for ID-PLUS / ID-MICRO	Right	MD1-D
			Pair	MD1-P
		for ID-BASIC	Right	MD2-D
			Pair	MD2-P
	Electrohydraulic kit for quick-connection (connection-disconnection)	In row weeder connection-disconnection Not available for ID-BASIC	Right	KER-IA-D
			Pair	KER-IA-P
	Adjustable row cleaner disc 11" (smooth disc)	Adaptable to in-row weeder	Right	BPI-D
			Pair	BPI-P
	Adjustable row cleaner disc 13" (notched disc)	Adaptable to in-row weeder	Right	BPID-D
			Pair	BPID-P
	Flange + Arm F + front smooth disc Ø 13" + double coil tines	Adaptable to frame	Right	BB001D
	*Not available for XXS y XS *It is not compatible with MREG-1		Pair	BB001P
	Flange + Arm F + front smooth disc Ø 16" + double coil tines	Adaptable to frame	Right	BB003D
	*Not available for XXS y XS *It is not compatible with MREG-1		Pair	BB003P
	Fix shank pre-undervine weeder blade made of elastomer	Adaptable to frame	Right	BELO01-D
			Pair	BELO01-P

	DESCRIPTION	OBSERVATIONS	REF.
	2 mechanical disc harrow	Ø16" Working with a max. width of 400mm	Right ADC2D
			Pair ADC2P
	3 mechanical disc harrow	Ø16" Working with a max. width of 550mm	Right ADC3D
			Pair ADC3P
	Soil restraint parallelogram kit	Only to combine with weeding blade, Ø300 rotor hoe, ploughshare and mini-disc plow	Right LP01-D
			Pair LP01-P
	Kit ID STAR 2 discs	Right	KIA-S2-D
	Kit ID STAR 3 discs		KIA-S3-D
	Kit ID STAR 2 discs	Pair	KIA-S2-P
	Kit ID STAR 3 discs		KIA-S3-P
	Extra price ID-STAR (3rd disc)	Right	ID-ST23-D
	Extra price ID-STAR (3rd disc)	Pair	ID-ST23-P

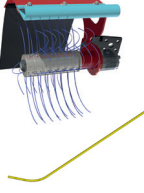
Undervine weeders

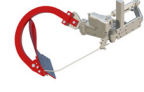
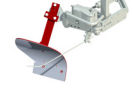







Tools for PARALLELOGRAM USE P

	DESCRIPTION	OBSERVATIONS	REF.
	Kit ID-ROLL Ø600	Right	KIA-R6-D
		Adaptable to in-row weeder	
	Kit ID-ROLL Ø600	Pair	KIA-R6-P
	Shoot remover kit + Sensor rod + String spool 250 mm working width	CR-XS	DBR25-4-D
		CR-S	DBR25-5-D
		CR-M	DBR25-6-D
		CR-L	DBR25-7-D
		CR-XS	DBR25-4-P
		CR-S	DBR25-5-P
		CR-M	DBR25-6-P
CR-L	DBR25-7-P		
	Arm B + fixed ploughshare + Sensor rod kit	310x480x400mm	Right BB-VFD
			Pair BB-VFP
	Arm C + adjustable ploughshare + sensor rod kit	410x540x430mm	Right BC-VRD
			Pair BC-VRP
	Arm E + fixed ploughshare with ridging element + sensor rod kit		Right BE-VFD
			Pair BE-VFP
	Retractable extra cleaner blade with spring for ploughshare		Right EM-D
			Pair EM-P

*Recommended oil cooler
Available only for vineyards with at least 40 cm free to the
ground or to any obstacle
Not available on Mod. XXS and XS

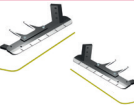
Undervine weeders

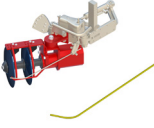
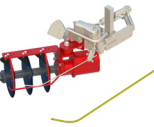
Tools for RADIAL USE [®]

		DESCRIPTION		OBSERVATIONS	REF.				
R		Arm D + weeding blade + sensor rod kit	Standard included	Right	BD-CPD				
				Pair	BD-CPP				
R		Kit weeding blade + sensor rod	Right	Cut 49 cm	RCI49D				
				Standard 55 cm	RCI55D				
				Long 65 cm	RCI65D				
R		Kit weeding blade + sensor rod	Pair	Cut 49 cm	RCI49P				
				Standard 55 cm	RCI55P				
				Long 65 cm	RCI65P				
R		Kit weeding blade made by Tugstene + sensor rod	Right		RCHD55D				
R		Kit weeding blade made by Tugstene + sensor rod	Pair	Standard 55 cm					
					RCHD55P				
		Retractable extra cleaner blade "V" for blade		Right	EV-D				
				Pair	EV-P				
		Blade shovel		Right	VO-D				
				Pair	VO-P				
R		Kit mini reversible plough kit 2 discs Ø13.5" + sensor rod	250 mm working width	CR-XS		MAD25-4-D			
				CR-S	Right	MAD25-5-D			
				CR-M		MAD25-6-D			
				CR-L		MAD25-7-D			
				CR-XS		MAD25-4-P			
				CR-S	Pair	MAD25-5-P			
				CR-M		MAD25-6-P			
				CR-L		MAD25-7-P			
				Recommended oil cooler and reinforced cylinder	CR-MAX	MAD25-8-P			
				R		Kit mini reversible plough kit 3 discs Ø13.5" + sensor rod	350 mm working width	CR-S	Right
CR-M		MAD35-6-D							
CR-L		MAD35-7-D							
CR-S		MAD35-5-P							
CR-M	Pair	MAD35-6-P							
CR-L		MAD35-7-P							
Recommended oil cooler and reinforced cylinder	CR-MAX	MAD35-8-P							
		Retractable extra cleaner blade for mini harrow disc						Right	EMD-D
								Pair	EMD-P
R		Kit Rotary hoe Ø300mm + sensor rod	*Possibility of simultaneous use with weeding blade (not included) Recommended oil cooler + reinforced cylinder					CR-XS	Right
				CR-S		RA30-5-D			
				CR-M		RA30-6-D			
				CR-L		RA30-7-D			
				CR-XS		RA30-4-P			
				CR-S	Pair	RA30-5-P			
				CR-M		RA30-6-P			
				CR-L		RA30-7-P			
		CR-MAX	RA30-8-P						

☐	DESCRIPTION	OBSERVATIONS		REF.		
	Kit Rotary hoe Ø400mm + Sensor rod	CR-XS	Right	RA40-4-D		
		CR-S		RA40-5-D		
		CR-M		RA40-6-D		
		CR-L		RA40-7-D		
		CR-XS	Pair	RA40-4-P		
		CR-S		RA40-5-P		
		CR-M		RA40-6-P		
		CR-L		RA40-7-P		
			*Possibility of simultaneous use with weeding blade (not included) Recommended oil cooler + reinforced cylinder	CR-MAX		RA40-8-P
			Kit Rotary hoe Ø500mm + Sensor rod	CR-S	Right	RA50-5-D
CR-M	RA50-6-D					
CR-L	RA50-7-D					
CR-S	Pair			RA50-5-P		
CR-M				RA50-6-P		
CR-L				RA50-7-P		
CR-MAX				RA50-8-P		
	Recommended oil cooler and reinforced cylinder					
	Kit string mower Ø400mm + Sensor rod + String reel			CR-XS	Right	GS40H-4-D
				CR-S		GS40H-5-D
		CR-M	GS40H-6-D			
		CR-L	Pair	GS40H-7-D		
		CR-XS		GS40H-4-P		
		CR-S		GS40H-5-P		
		CR-M		GS40H-6-P		
		CR-L	GS40H-7-P			
			*Recommended oil cooler	CR-MAX		GS40H-8-P
			Kit string mower Ø500mm + Sensor rod + String reel	CR-XS	Right	GS50H-4-D
CR-S	GS50H-5-D					
CR-M	GS50H-6-D					
CR-L	Pair			GS50H-7-D		
CR-XS				GS50H-4-P		
CR-S				GS50H-5-P		
CR-M				GS50H-6-P		
CR-L	GS50H-7-P					
	*Recommended oil cooler			CR-MAX		GS50H-8-P
	Kit string mower Ø600mm + Sensor rod + String reel			CR-S	Right	GS60H-5-D
		CR-M	GS60H-6-D			
		CR-L	GS60H-7-D			
		CR-S	Pair It needs the system ID-PLUS DUAL	GS60H-5-P		
		CR-M		GS60H-6-P		
		CR-L		GS60H-7-P		
		CR-MAX		GS60H-8-P		
	*Recommended oil cooler					
	Kit for modification of string mower with boron steel blades	Only available for new machine	Right	KSGSH-D		
			Pair	KSGSH-P		
	Square string spool	for mower	45 m	BHN-03		
	Nylon string blue spool	for brush head	90 m	BHN-01		
	Herbicide application head	Ø500	Right	AH50D		
			Pair	AH50P		
	Kit fix rotors Ø500 + Pair of rotors Ø400mm at undervine weeder	CR-L and CR-MAX *It needs the remote control ID-PLUS DUAL	Only available for new machine	KRFRM-P		
	Packaging	Basic		EMB-1		
		Airfreight- oceanfreight		EMB-3		

Ideal products and services that inspire trust, quality, experience and excellence

Specialized and customized agricultural machines with an attractive design and increasing digitalizations. Our products are oriented towards a biological, environment-friendly and precision farming.



INDUSTRIAS DAVID S.L.U.
C/ Médico Miguel Lucas s/n
CP: 30510, Yecla, Murcia-Spain
Tel.: +34 968 718 119
info@id-david.com

Connect with us.
[instagram.com/iddavid_official](https://www.instagram.com/iddavid_official)
twitter.com/IDdavidslu
[facebook.com/industriasdavid](https://www.facebook.com/industriasdavid)
[linkedin.com/company/id-david](https://www.linkedin.com/company/id-david)
[youtube.com/industriasdavid](https://www.youtube.com/industriasdavid)

www.id-david.com

