

ID-FRONT

EN

*Front and extendable in-row
holder frame*



VITI

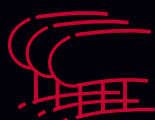

SETO



ARBO



DAVID
SMART FARMING SOLUTIONS

SERIE

ID-FRONT



Front and extendable in-row holder frame adaptable to any tractor without the front 3rd PTO linkage, designed for tillage and weeding inside plants.

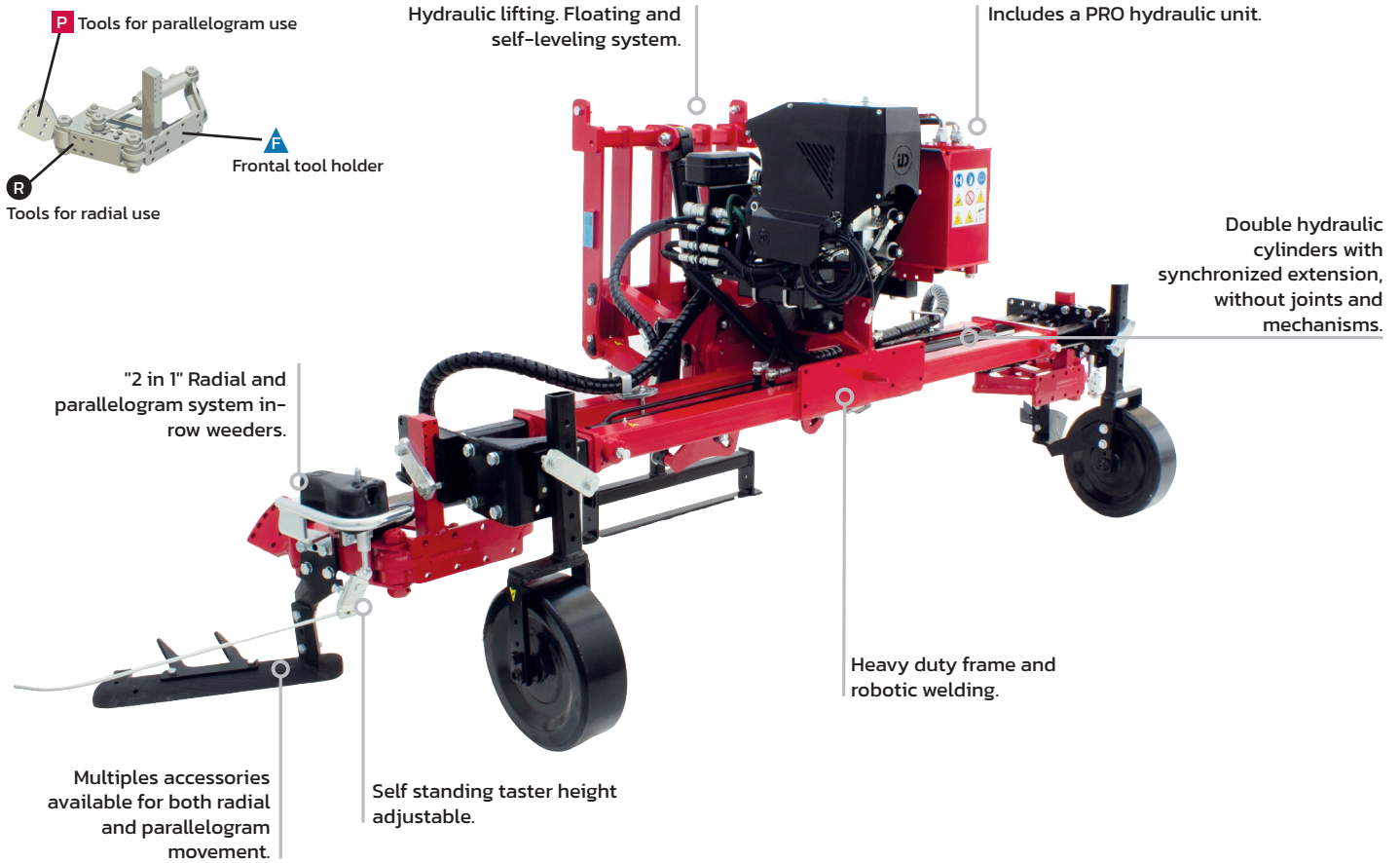

PICTURE MODEL:
CF-M-P + BA-EC

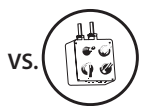
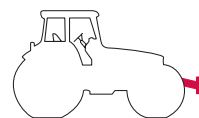

Versatility

- The widest range of products and accessories on the market. A custom configuration to suit your needs.
- Different tools that allow both surface and tillage works up to 20 cm deep.
- The ID-CONTROL joystick allows to control all the machines manufactured by ID David and equipped with the ID-PLUS or ID-MICRO technology.

Reliability

- Components and materials of high quality from certified manufacturers.
- Heavy duty frame and robotic welding.
- Great visibility of the rows.
- Experience in the manufacture of electrohydraulic undervine weeders since 1974.

Exclusivity

- The exclusive undervine weeder that combines the "parallelogram-radial" movement.
- Faster, safer and endowed with unmatched versatility thanks to its triple tool holder.
- Opportunity to work between plants starting from 1 cm diameter thanks to our adjustable and progressive electronic sensor, the arm is moving at the right time to save the plant.

Safety

- As standard all models are fitted with an exclusive safety locking system in case of faults.
- Enables route deviations up to 30 cm in the plantation rows.
- Our equipment incorporates easy, comfortable and safe tool replacement systems.

Effectiveness

- Time is valuable, it is possible to work up to 12 km/h with a standard soil conditions.
- The easy adjusting of hydraulic pressure of the in row weeder assured a perfect work in any type of soil.
- Floating and tilting system for a perfect adaptation to the ground.

Sustainability

- Ecological alternative to the use of herbicides.
- The low power required allows the use of small tractors with a lower carbon footprint.
- Improves the structure and porosity of the soil.

Standard Equipment

- Includes a PRO hydraulic unit.
- Anti-shock sensor protector.
- Adaptable standard plate to tractor (frontal).
- Hydraulic pressure regulator.
- Electro hydraulic in row weeder.
- Hydraulic width adjusting to the tractor.
- Floating elevation cylinder.
- Tool kit for sensor regulation.
- Arm "D" and blade manufactured in boron steel.
- Quick coupling kit for power tools.
- Special rod sensor in high tensile steel.
- Pair of metallic smooth wheels width and height adjustable for Model XS and S
- Smooth Wheels assembly on the extension model M and L.
- Storage foot.
- +/- 10° Mechanical tilting system (hydraulic as an option).

Remote control type

ID-PLUS

- Includes ID-CONTROL multifunction joystick.
- Includes ON-OFF of powered tools.
- Includes an electronic microcontroller: allows software updates at any time.
- Up to 4 additional electro-hydraulic functions.
- Includes a modular electro-hydraulic system: it allows to increase the number of electro-hydraulic functions.

ID-MICRO

- ! NOT included the ID-CONTROL multifunction joystick.
- Only for customers who already have the ID-CONTROL multifunction joystick.
- Includes ON-OFF of powered tools.
- Includes an electronic microcontroller: allows software updates at any time.
- Up to 4 additional electro-hydraulic functions.
- Includes a modular electro-hydraulic system: it allows to increase the number of electro-hydraulic functions.

ID-BASIC

- Includes an electric control box.
- Max. 1 additional electro-hydraulic function to choose between: PI-002 / PI-004 / EH-EC / CRA-EC / IH-EC / BA-EC / IEE-01
- ! NOT allowed any updates of electro-hydraulic functions.



ID-PLUS DUAL

- Includes ID-CONTROL multifunction joystick.
- Includes ON-OFF of powered tools.
- Includes cooler and double pump.
- Includes an electronic microcontroller: allows software updates at any time.
- Up to 4 additional electro-hydraulic functions.
- Includes a modular electro-hydraulic system: it allows to increase the number of electro-hydraulic functions.

						
ID-FRONT	cm	m	REF.	REF.	REF.	REF.
1 IN ROW WEEDER 	49	≥ 1,50	CF-XS-1-D	CF-XS-2-D	CF-XS-3-D	CF-XS-4-D
	55	≥ 1,85	CF-S-1-D	CF-S-2-D	CF-S-3-D	CF-S-4-D
	55	≥ 2,45	CF-M-1-D	CF-M-2-D	CF-M-3-D	CF-M-4-D
	65	≥ 2,90	CF-L-1-D	CF-L-2-D	CF-L-3-D	CF-L-4-D
2 IN ROW WEEDER 	49	1,50-2,05	CF-XS-1-P	CF-XS-2-P	CF-XS-3-P	CF-XS-4-P
	55	1,85-2,60	CF-S-1-P	CF-S-2-P	CF-S-3-P	CF-S-4-P
	55	2,45-3,20	CF-M-1-P	CF-M-2-P	CF-M-3-P	CF-M-4-P
	65	2,90-4,00	CF-L-1-P	CF-L-2-P	CF-L-3-P	CF-L-4-P



Technical details

		X			L	W	H
ID-FRONT	REF.	m	kg	HP	m	m	m
1 IN ROW WEEDER	CF-XS-D	≥ 1,50	550	35	1,30	0,90	1,35
	CF-S-D	≥ 1,85	600	35	1,20	1,05	1,35
	CF-M-D	≥ 2,45	715	40	1,20	1,60	1,35
	CF-L-D	≥ 2,90	750	45	1,20	1,90	1,35
2 IN ROW WEEDER	CF-XS-P	1,50-2,05	600	40	1,30	1,00	1,35
	CF-S-P	1,85-2,60	650	40	1,20	1,35	1,35
	CF-M-P	2,45-3,20	765	45	1,20	1,90	1,35
	CF-L-P	2,90-4,00	800	50	1,20	2,20	1,35

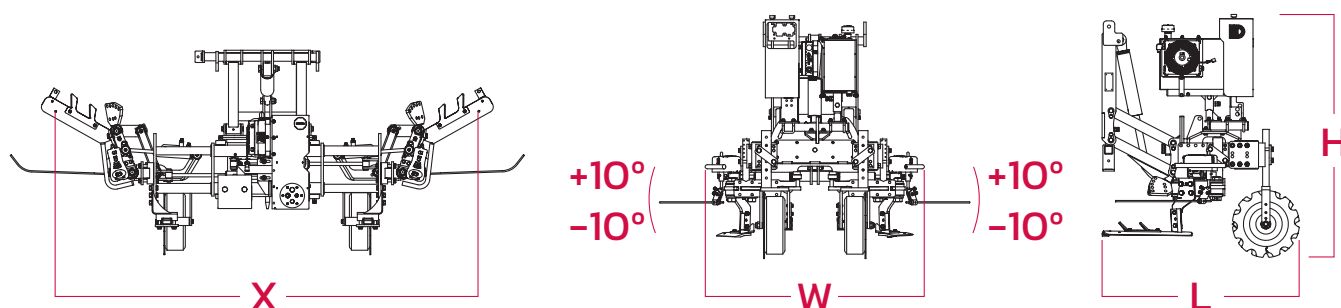

Tractor mounting

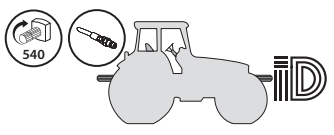
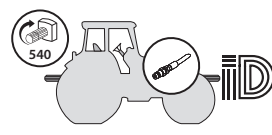
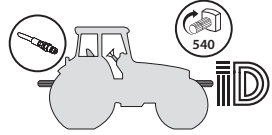
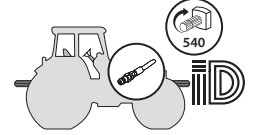
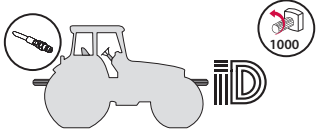
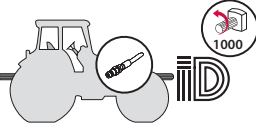
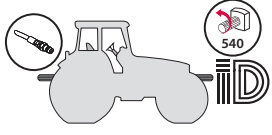
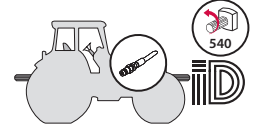

Tractor connection and assembling

			
STANDARD	REF. CMT-6	REF. CMT-12	REF. CMT-7
			
REF. CMT-14	REF. CMT-9	REF. CMT-13	REF. CMT-8



Chassis

Accessories and Options

	DESCRIPTION	OBSERVATIONS	REF.
	Plate for front tractor coupling	It will be supplied only if the corresponding form has been correctly filled out	PA-F
	Over full plate extension	120 mm Not available for XS	SEC-12
	Solenoid valve for hydraulic extension	Integrated in control box 	EH-EC
	Pair of smooth wheels recommended for sandy soil	Replace the standard Not compatible with shank F. Not compatible with shank elastomer.	MREG-1
	Pair of front pneumatic wheels	Replaces the metal wheels	RND-P
	Hydraulic adjustment of working height *Incompatible with wheels mounted on extensions	Direct to tractor, it replace the standard wheels frame 	CRA-DT-1
		Electric to replace the standard wheels frame	CRA-EC
	Tilting frame	Directly to the tractor 	BA-DT
		Electric cabine	BA-EC
	Flange + Arm F + front smooth disc Ø 13" + double coil tines	Adaptable to frame Not available for XS It is not compatible with MREG-1	Right BB001D
			Pair BB001P
	Flange + Arm F + front smooth disc Ø 16" + double coil tines	Adaptable to frame Not available for XS It is not compatible with MREG-1	Right BB003D
			Pair BB003P
	Fix shank pre-undervine weeder blade made of elastomer	Adaptable to frame	Right BELO01-D
			Pair BELO01-P
	Solenoid valve installation for electrohydraulic lifting Incompatible with CRA-DT-1 y CRA-EC		IEE-01

Pre-installations and updates

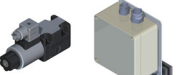
Accessories and Options

	DESCRIPTION	OBSERVATIONS	REF.
	Pre-installation in-row weeder left side/electrohydraulic system	Including extension and cylinder	PI-011
	Pre-installation solenoid valve	1 extra function double acting	PI-002
		on/off motorized tools	for ID-BASIC PI-004
	PTO gearbox with male output	For combined use with other equipment Replace the standard	ML52SM





Undervine weeders

Accessories and Options

	DESCRIPTION	OBSERVATIONS	REF.
	Standard oil cooler	Adaptable to PRO hydraulic power plant	Intake 12V A15-01-PRO
	Pressure filter kit + oil cooler	Replaces hydraulic power plant. Not available for ID-PLUS DUAL.	Intake 12V Tractor plugs connection.  KFP-03
	Hydraulic side slope correction for in-row weeders	Directly to the tractor	Unit  IH-DT
	*Increases working width of 10 cm Inclination: + 21°, -10°	Electric cabine	Unit IH-EC
	Grass bend down system		Right STH-D
			Pair STH-P
	Ultrasensible kit for sensitive sensor	Ideal vineyards ≤ 1 cm	Unit KU-1
	Reinforced in row weeder cylinder for hard soil	Replaces standard cylinder. Recommended oil cooler.	Unit CIA-R
	Electrohydraulic kit for quick-connection (connection-disconnection)	In row weeder connection-disconnection Not available for ID-BASIC	Right KER-IA-D
			Pair KER-IA-P
	Adjustable row cleaner disc 11" (smooth disc)	Adaptable to in-row weeder	Right BPI-D
			Pair BPI-P
	Adjustable row cleaner disc 13" (notched disc)	Adaptable to in-row weeder	Right BPID-D
			Pair BPID-P
	2 mechanical disc harrow	Ø16" Working with a max. width of 400mm	Right ADC2D
			Pair ADC2P
	3 mechanical disc harrow	Ø16" Working with a max. width of 550mm	Right ADC3D
			Pair ADC3P
	Soil restraint parallelogram kit	Only to combine with weeding blade, Ø300 rotor hoe, ploughshare and mini-disc plow	Right LPO1-D
			Pair LPO1-P
	Kit ID STAR 2 discs		Right KIA-S2-D
			Adaptable to in-row weeder KIA-S3-D
	Kit ID STAR 3 discs		Pair KIA-S2-P
			Pair KIA-S3-P
	Extra price ID-STAR (3rd disc)		Right ID-ST23-D
			Pair ID-ST23-P



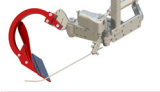
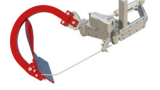
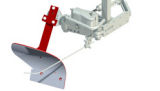



Undervine weeders





Tools for PARALLELOGRAM USE P

📷	DESCRIPTION	OBSERVATIONS	REF.
	Kit ID-ROLL Ø600	Right	KIA-R6-D
	Kit ID-ROLL Ø600	Pair	KIA-R6-P
	Shoot remover kit + Sensor rod + String spool 250 mm working width <small>*Recommended oil cooler Available only for vineyards with at least 40 cm free to the ground or to any obstacle</small>	CF-XS	DBR25-4-D
		CF-S	DBR25-5-D
		CF-M	DBR25-6-D
		CF-L	DBR25-7-D
		CF-XS	DBR25-4-P
		CF-S	DBR25-5-P
		CF-M	DBR25-6-P
	Arm B + fixed ploughshare + Sensor rod kit	310x480x400mm	Right BB-VFD
			Pair BB-VFP
	Arm C + adjustable ploughshare + sensor rod kit	410x540x430mm	Right BC-VRD
			Pair BC-VRP
	Arm E + fixed ploughshare with ridging element + sensor rod kit		Right BE-VFD
			Pair BE-VFP
	Retractable extra cleaner blade with spring for ploughshare		Right EM-D
			Pair EM-P

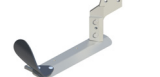
Undervine weeders

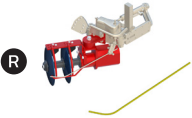
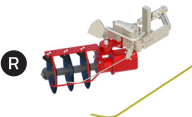
Tools for RADIAL USE R

📷	DESCRIPTION	OBSERVATIONS	REF.
	Arm D + weeding blade + sensor rod kit	Standard included	Right BD-CPD
			Pair BD-CPP
	Kit right weeding blade + sensor rod		Cut 49 cm RCI49D
			Standard 55 cm RCI55D
			Long 65 cm RCI65D
	Kit pair of weeding blade + sensor rod		Cut 49 cm RCI49P
			Standard 55 cm RCI55P
			Long 65 cm RCI65P
	Kit weeding blade made by Tugstene + sensor rod	Right	Standard 55 cm RCHD55D
	Kit weeding blade made by Tugstene + sensor rod	Pair	RCHD55P
	Retractable extra cleaner blade "V" for blade		Right EV-D
			Pair EV-P
	Blade shovel		Right VO-D
			Pair VO-P

☐	DESCRIPTION	OBSERVATIONS	REF.		
	Kit mini reversible plough kit 2 discs Ø13.5" + sensor rod 250 mm working width Recommended oil cooler and reinforced cylinder	CF-XS	MAD25-4-D		
		CF-S	MAD25-5-D		
		CF-M	MAD25-6-D		
		CF-L	MAD25-7-D		
		CF-XS	MAD25-4-P		
		CF-S	MAD25-5-P		
		CF-M	MAD25-6-P		
		CF-L	MAD25-7-P		
	Kit mini reversible plough kit 3 discs Ø13.5" + sensor rod 350 mm working width Recommended oil cooler and reinforced cylinder	CF-S	MAD35-5-D		
		CF-M	MAD35-6-D		
		CF-L	MAD35-7-D		
		CF-S	MAD35-5-P		
		CF-M	MAD35-6-P		
		CF-L	MAD35-7-P		
			Retractable extra cleaner blade for mini harrow disc	Right	EMD-D
				Pair	EMD-P
	Kit Rotary hoe Ø300mm + sensor rod *Possibility of simultaneous use with weeding blade (not included) Recommended oil cooler + reinforced cylinder	CF-XS	RA30-4-D		
		CF-S	RA30-5-D		
		CF-M	RA30-6-D		
		CF-L	RA30-7-D		
		CF-XS	RA30-4-P		
		CF-S	RA30-5-P		
		CF-M	RA30-6-P		
		CF-L	RA30-7-P		
	Kit Rotary hoe Ø400mm + Sensor rod *Possibility of simultaneous use with weeding blade (not included) Recommended oil cooler + reinforced cylinder	CF-XS	RA40-4-D		
		CF-S	RA40-5-D		
		CF-M	RA40-6-D		
		CF-L	RA40-7-D		
		CF-XS	RA40-4-P		
		CF-S	RA40-5-P		
		CF-M	RA40-6-P		
		CF-L	RA40-7-P		
	Kit Rotary hoe Ø500mm + Sensor rod Recommended oil cooler and reinforced cylinder	CF-S	RA50-5-D		
		CF-M	RA50-6-D		
		CF-L	RA50-7-D		
		CF-S	RA50-5-P		
		CF-M	RA50-6-P		
		CF-L	RA50-7-P		

	DESCRIPTION	OBSERVATIONS	REF.
	Kit string mower Ø400mm + Sensor rod + String reel	CF-XS	GS40H-4-D
		CF-S	GS40H-5-D
		CF-M	GS40H-6-D
		CF-L	GS40H-7-D
		CF-XS	GS40H-4-P
		CF-S	GS40H-5-P
		CF-M	GS40H-6-P
		CF-L	GS40H-7-P
		*Recommended oil cooler	
	Kit string mower Ø500mm + Sensor rod + String reel	CF-XS	GS50H-4-D
		CF-S	GS50H-5-D
		CF-M	GS50H-6-D
		CF-L	GS50H-7-D
		CF-XS	GS50H-4-P
		CF-S	GS50H-5-P
		CF-M	GS50H-6-P
		CF-L	GS50H-7-P
		*Recommended oil cooler	
	Kit string mower Ø600mm + Sensor rod + String reel	CF-S	GS60H-5-D
		CF-M	GS60H-6-D
		CF-L	GS60H-7-D
		CF-S	GS60H-5-P
		CF-M	GS60H-6-P
		CF-L	GS60H-7-P
*Recommended oil cooler			
	Kit for modification of string mower with boron steel blades	Only available for new machine	
	Square string spool	for mower	
	Nylon string blue spool	for brush head	
	Herbicide application head	Ø500	
	Packaging	Basic	
		Airfreight- oceanfreight	

Ideal products and services that inspire trust, quality, experience and excellence

Specialized and customized agricultural machines with an attractive design and increasing digitalizations. Our products are oriented towards a biological, environment-friendly and precision farming.



INDUSTRIAS DAVID S.L.U.
C/ Médico Miguel Lucas s/n
CP: 30510, Yecla, Murcia-Spain
Tel.: +34 968 718 119
info@id-david.com

Connect with us.
[instagram.com/iddavid_official](https://www.instagram.com/iddavid_official)
twitter.com/IDdavidslu
[facebook.com/industriasdavid](https://www.facebook.com/industriasdavid)
[linkedin.com/company/id-david](https://www.linkedin.com/company/id-david)
[youtube.com/industriasdavid](https://www.youtube.com/industriasdavid)

www.id-david.com

