

BIO

EN

Extendable in-row weeder frame for the simultaneous maintenance of cover crop in the central row and weeding inside plants

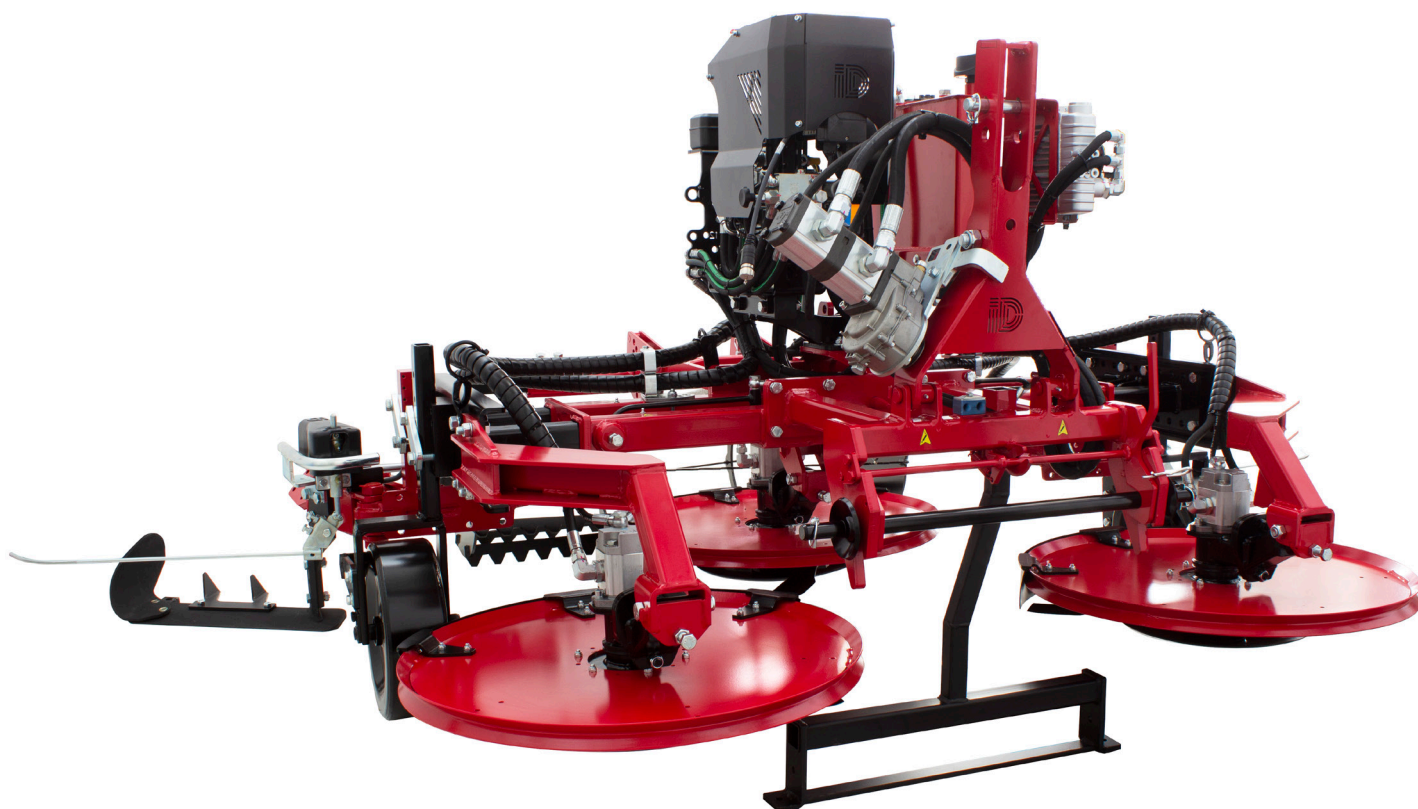

VITI



SETO



ARBO



DAVID
SMART FARMING SOLUTIONS

SERIE

BIO



Extendable in-row weeder frame for the simultaneous maintenance of cover crop in the central row and weeding inside plants.

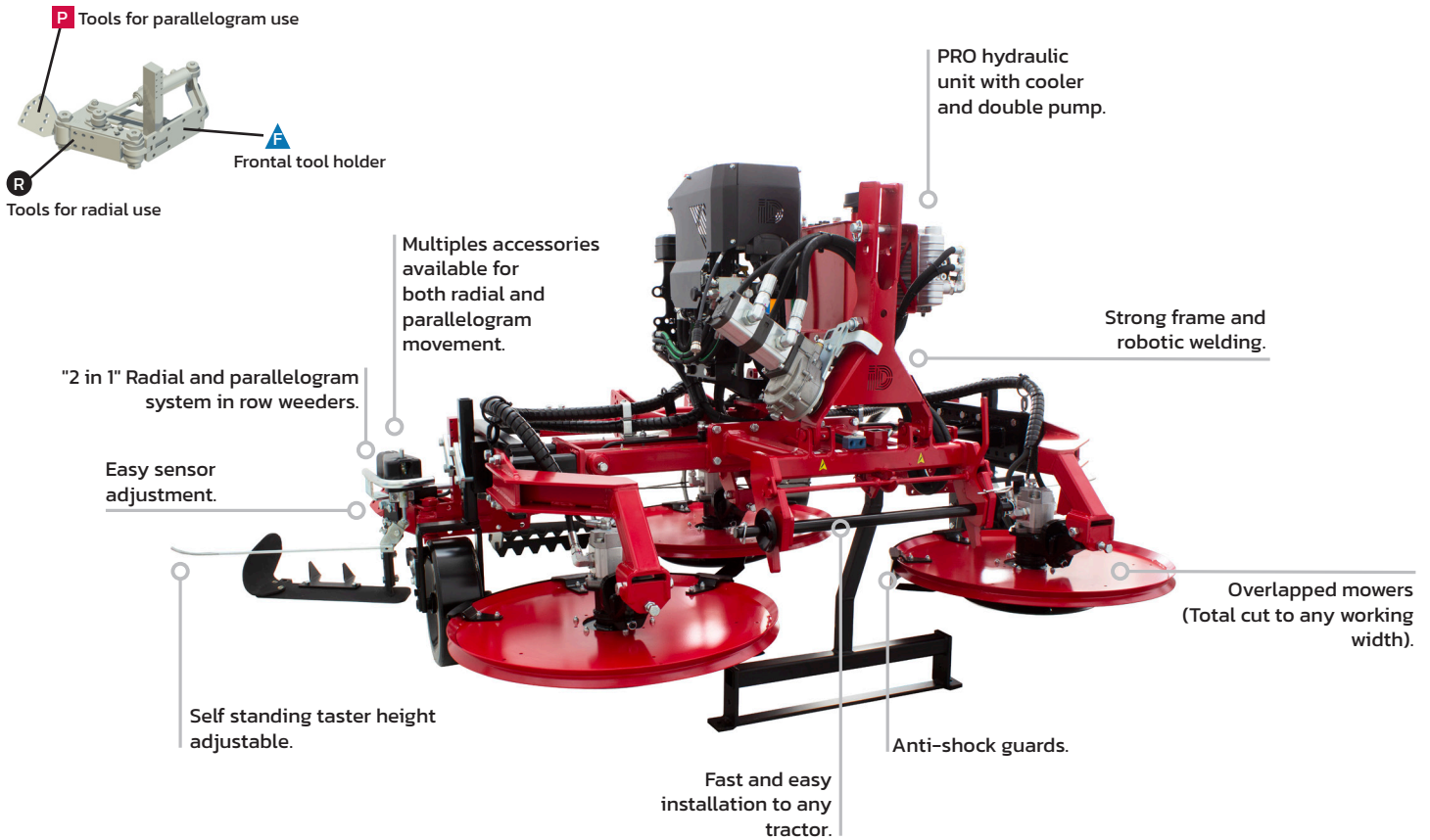

PICTURE MODEL:
BIO-M + EH-EC + RF4B



Versatility

- The widest range of products and accessories on the market. A custom configuration to suit your needs.
- Different tools that allow both surface and tillage works up to 20 cm deep.
- The ID-CONTROL joystick allows to control all the machines manufactured by ID David and equipped with the ID-PLUS or ID-MICRO technology.

Reliability

- Components and materials of high quality from certified manufacturers.
- Heavy duty frame and robotic welding.
- Great visibility of the rows.
- Experience on manufacturing of electrohydraulic in-row weeder since 1974.

Exclusivity

- The exclusive undervine weeder that combines the "parallelogram-radial" movement.
- Faster, safer and endowed with unmatched versatility thanks to its triple tool holder.
- Opportunity to work between plants starting from 1 cm diameter thanks to our adjustable and progressive electronic sensor, the arm is moving at the right time to save the plant.

Safety

- As standard all models are fitted with an exclusive safety locking system in case of faults.
- Enables route deviations up to 30 cm in the plantation/rows.
- Our equipment incorporates easy, comfortable and safe tool replacement systems.

Effectiveness

- Time is valuable, it is possible to work up to 12 km/h with a standard soil conditions.
- The easy adjusting of hydraulic pressure of the in-row weeder assure a great work in any type of soil.
- Reduction of soil working time by 50%, because in a single pass we maintain the cover crop in the central row while working under the plant.

Sustainability

- Ecological alternative to the use of herbicides.
- The low power required as well as the performance of 2 tasks simultaneously, allows the use of small tractors and consequently a lower carbon footprint.
- Improves the biodiversity, structure and porosity of the soil.

Standard Equipment

- Includes a PRO hydraulic unit with cooler and double pump.
- Anti-shock sensor protector.
- Hydraulic pressure regulator.
- Electro hydraulic in row weeder.
- Hydraulic width adjusting to the tractor.
- Tool kit for sensor regulation.
- Arm "D" and blade manufactured in boron steel.
- Quick coupling kit for power tools.
- Pair of metallic wheels height adjustable for Model XS and S.
- Rotary slasher equipped with deflector and floating system.
- Storage foot.
- Quick coupling.
- Wheels assembly on the extension model M and L.





Remote control type

ID-PLUS DUAL

- Includes ID-CONTROL multifunction joystick.
- Includes ON-OFF of powered tools.
- Includes ON-OFF of central mowers.
- Includes an electronic microcontroller: allows software updates at any time.
- Up to 3 additional electro-hydraulic functions.
- Includes a modular electro-hydraulic system: it allows to increase the number of electro-hydraulic functions.

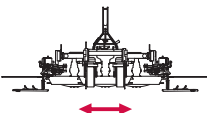

ID-MICRO DUAL

- ! NOT includes ID-CONTROL multifunction joystick.
- Only for customers who already have the ID-CONTROL multifunction joystick.
- Includes ON-OFF of powered tools.
- Includes ON-OFF of central mowers.
- Includes an electronic microcontroller: allows software updates at any time.
- Up to 3 additional electro-hydraulic functions.
- Includes a modular electro-hydraulic system: it allows to increase the number of electro-hydraulic functions.

			ID-PLUS DUAL 	ID-MICRO DUAL 
BIO	cm	m	REF.	REF.
2 IN ROW WEEDER	49	1,50-2,05	BIO-XS-4	BIO-XS-6
	55	1,85-2,60	BIO-S-4	BIO-S-6
	55	2,45-3,20	BIO-M-4	BIO-M-6
	65	3,00-4,15	BIO-L-4	BIO-L-6



Technical details

BIO	REF.	X	A			L	W	H
		m	m	kg	HP	m	m	m
2 IN ROW WEEDER	BIO-XS	1,50-2,05	0,90-1,30	590	50	1,85	1,00	1,35
	BIO-S	1,85-2,60	1,25-1,80	680	50	2,20	1,35	1,35
	BIO-M	2,45-3,20	1,70-2,40	730	60	1,60	1,85	1,35
	BIO-L	3,00-4,15	2,10-3,10	830	60	1,60	2,50	1,35

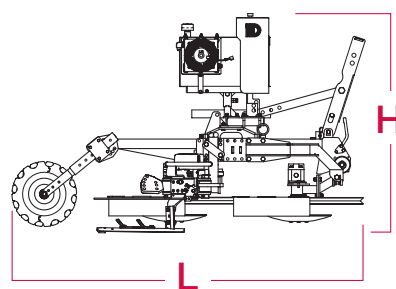
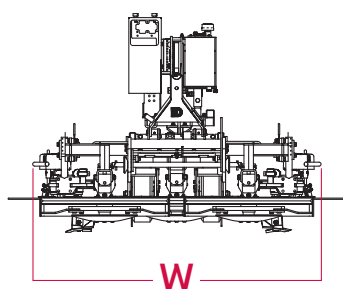
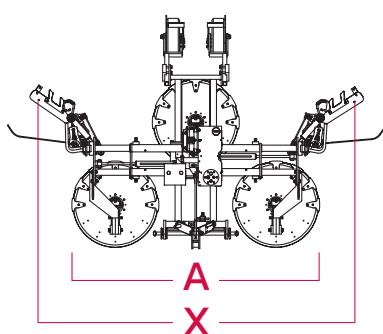



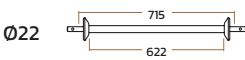
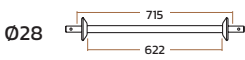
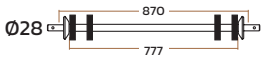

Drawbar

			
	REF. BE-2271	STANDARD	REF. BE-2887
BIO-XS	•	S	•
BIO-S	•	S	•
BIO-M	•	S	•
BIO-L	•	S	•





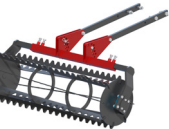

S Standard
 • Optional
 (Replace standard)

Chassis Accessories and Options

	DESCRIPTION	OBSERVATIONS	REF.	
	Hydraulic 3 point hitch	Directly to the tractor	 TH-DT	
	Solenoid valve for hydraulic extension	Integrated in control box	 EH-EC	
	Roller Ø40cm fix helical	Replaces wheels	RF4BSY	
		Extra	1,75 m - BIO-M	RF4B
		Replaces wheels	RF5BSY	
		Extra	2,25 m - BIO-L	RF5B
	*Only for M & L models			



Undervine weeders

Accessories and Options

	DESCRIPTION	OBSERVATIONS	REF.
	Hydraulic side slope correction for in-row weeders *Increases working width of 10 cm Inclination: + 21°, -10°	Directly to the tractor Electric cabine	Unit  IH-DT IH-EC
	Grass bend down system		Pair STH-P
	Ultrasensible kit for sensitive sensor	Ideal vineyards ≤ 1 cm	Unit KU-1
	Reinforced in row weeder cylinder for hard soil	Replaces standard cylinder. Recommended oil cooler.	Unit CIA-R
	Electrohydraulic kit for quick-connection (connection-disconnection)	In row weeder connection-disconnection Not available for ID-BASIC	Pair KER-IA-P



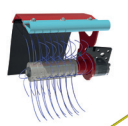
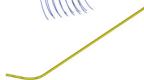

Undervine weeders



Tools for PARALLELOGRAM USE P



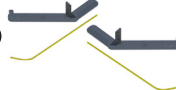

	DESCRIPTION	OBSERVATIONS	REF.
	Shoot remover kit + Sensor rod + String spool	BIO-XS	DBR25-4-P
	250 mm working width	BIO-S	DBR25-5-P
		BIO-M	DBR25-6-P
	*Recommended oil cooler Available only for vineyards with at least 40 cm free to the ground or to any obstacle	BIO-L	DBR25-7-P
	Arm E + fixed ploughshare with ridging element + sensor rod kit		Pair BE-VFP

Undervine weeders

Tools for RADIAL USE R

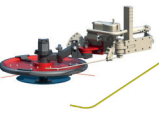
	DESCRIPTION	OBSERVATIONS	REF.
	Arm D + weeding blade + sensor rod kit	Standard included	Pair BD-CPP
	Kit pair of weeding blade + sensor rod	Cut 49 cm	RCI49P
		Standard 55 cm	RCI55P
		Long 65 cm	RCI65P
	Kit pair of weeding blade type Boomerang + sensor rod	Recommended Reinforced Cylinder	100 cm (82E + 20I cm) RB8220P
	Kit weeding blade made by Tugstene + sensor rod	Pair	Standard 55 cm RCHD55P
	Retractable extra cleaner blade "V" for blade		Right EV-D
			Pair EV-P

☐	DESCRIPTION	OBSERVATIONS	REF.
	Blade shovel	Right	VO-D
		Pair	VO-P
R	Kit mini reversible plough kit 2 discs Ø13.5" + sensor rod	BIO-XS	MAD25-4-P
		BIO-S	MAD25-5-P
	250 mm working width	BIO-M	MAD25-6-P
	Recommended oil cooler and reinforced cylinder	BIO-L	MAD25-7-P
	Retractable extra cleaner blade for mini harrow disc	Pair	EMD-P
R	Kit Rotary hoe Ø300mm + sensor rod	BIO-XS	RA30-4-P
		BIO-S	RA30-5-P
		BIO-M	RA30-6-P
	*Possibility of simultaneous use with weeding blade (not included) Recommended oil cooler + reinforced cylinder	BIO-L	RA30-7-P
R	Kit Rotary hoe Ø400mm + Sensor rod	BIO-XS	RA40-4-P
		BIO-S	RA40-5-P
		BIO-M	RA40-6-P
	*Possibility of simultaneous use with weeding blade (not included) Recommended oil cooler + reinforced cylinder	BIO-L	RA40-7-P
R	Kit Rotary hoe Ø500mm + Sensor rod	BIO-XS	RA50-4-P
		BIO-S	RA50-5-P
		BIO-M	RA50-6-P
	Recommended oil cooler and reinforced cylinder	BIO-L	RA50-7-P
R	Kit string mower Ø400mm + Sensor rod + String reel	BIO-S	GS40H-5-P
		Pair	
		BIO-M	GS40H-6-P
	*Recommended oil cooler Not available on Mod. BIO-XS / BIO-L		
R	Kit string mower Ø500mm + Sensor rod + String reel	BIO-S	GS50H-5-P
		Pair	
		BIO-M	GS50H-6-P
	*Recommended oil cooler Not available on Mod. BIO-XS / BIO-L		

☐	DESCRIPTION	OBSERVATIONS		REF.
R	 <p data-bbox="256 129 592 224"> Kit string mower Ø600mm + Sensor rod + String reel </p> <p data-bbox="256 235 632 277"> <small>*Recommended oil cooler Not available on Mod. BIO-XS / BIO S / BIO-L</small> </p>	BIO-M	Pair	GS60H-6-P
	 <p data-bbox="256 315 740 371"> Kit for modification of string mower with boron steel blades </p>	Only available for new machine	Pair	KSGSH-P
	 <p data-bbox="256 450 491 483"> Square string spool </p>	for mower	45 m	BHN-03
	 <p data-bbox="256 573 536 607"> Nylon string blue spool </p>	for brush head	90 m	BHN-01
	 <p data-bbox="256 696 379 730"> Packaging </p>	Basic		EMB-1
		Airfreight- oceanfreight		EMB-3

Ideal products and services that inspire trust, quality, experience and excellence

Specialized and customized agricultural machines with an attractive design and increasing digitalizations. Our products are oriented towards a biological, environment-friendly and precision farming.



INDUSTRIAS DAVID S.L.U.
C/ Médico Miguel Lucas s/n
CP: 30510, Yecla, Murcia-Spain
Tel.: +34 968 718 119
info@id-david.com

Connect with us.
[instagram.com/iddavid_official](https://www.instagram.com/iddavid_official)
twitter.com/IDdavidslu
[facebook.com/industriasdavid](https://www.facebook.com/industriasdavid)
[linkedin.com/company/id-david](https://www.linkedin.com/company/id-david)
[youtube.com/industriasdavid](https://www.youtube.com/industriasdavid)

www.id-david.com

