

ECO-CUT

EN

Single front frame equipped with retractable mower



SERIE

ECO-CUT



Single front frame equipped with retractable mower. Design to work in plantations with slopes, ridges or terraces. It adapts millimetrically to the terrain thanks to its flotation system and the multi-position support wheel.

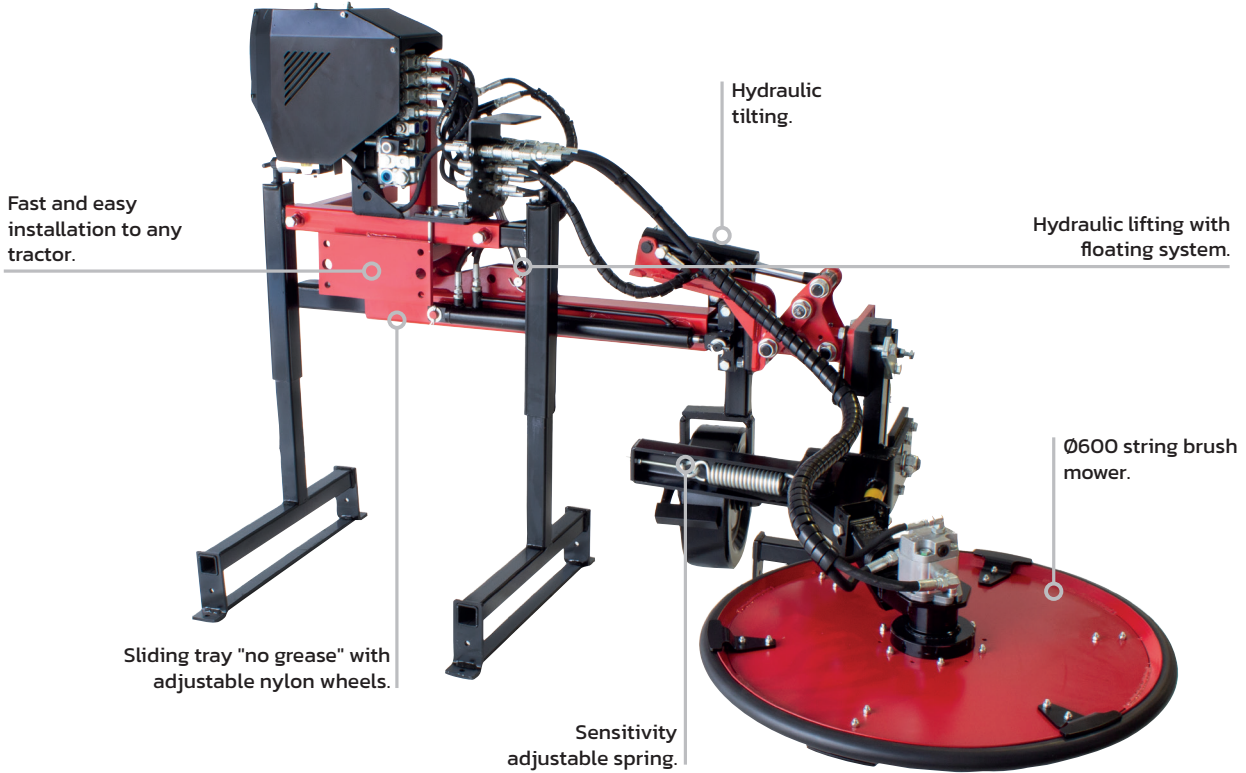

PICTURE MODEL:
ECUT-6

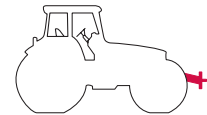

Versatility

- A multitude of accessories available.
- The ID-CONTROL joystick allows to control all the machines manufactured by ID David and equipped with the ID-PLUS or ID-MICRO technology.

Exclusivity

- Strong lawn mower with blades or nylon threads suitable for grass cutting. Its particular design provides maximum protection to the plants, as well as a minimal maintenance.
- To work under adult plants thanks to the retractable arm adjustable in sensitivity. The arm moves the necessary to save the plant at the right time.

Effectiveness

- Electrohydraulic system optimized for extremely low power consumption.
- Great work on every type of soil.
- The long hydraulic extension allows to work on large crowned trees.

Reliability

- Components and materials of high quality.
- Heavy duty frame and robotic welding.
- Manufacturing experience since 1974.

Safety

- Great visibility of the rows.
- Pivoting system for a perfect adjustment to the ground.
- Our equipment incorporates easy, comfortable and safe tool replacement systems.

Sustainability

- Ecological alternative to the use of herbicides.
- The low power required allows the use of small tractors with a lower carbon footprint.

Standard Equipment

- Electrohydraulic extension.
- Floating and surface adaptable wheel.
- Legs with spindle for height adjustment (easy coupling to tractor).
- Electrohydraulic tilting.
- Electrohydraulic lifting (floating or double effect).
- Standard coupling part to tractor.
- Quick connect kit for power tools.
- Spring retractable string brush cutter.
- Mulcher of 800 or 1000 mm with floating system (according to the model).

Remote control type

ID-PLUS







- Includes ID-CONTROL multifunction joystick.
- Includes ON-OFF of powered tools.
- Includes an electronic microcontroller: allows software updates at any time.
- Up to 3 additional electro-hydraulic functions.
- Includes a modular electro-hydraulic system: it allows to increase the number of electro-hydraulic functions.

ID-MICRO

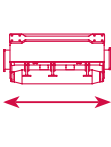
- ! Not included the ID-CONTROL multifunction joystick.
- Only for customers who already have the ID-CONTROL multifunction joystick.
 - Includes ON-OFF of powered tools.
 - Includes an electronic microcontroller: allows software updates at any time.
 - Up to 3 additional electro-hydraulic functions.
 - Includes a modular electro-hydraulic system: it allows to increase the number of electro-hydraulic functions.

ID-PLUS DUAL

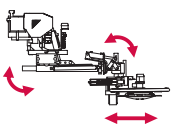
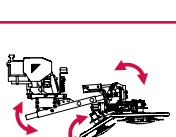
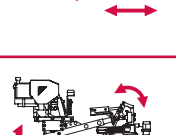

- Includes ID-CONTROL multifunction joystick.
- It includes DOUBLE ON-OFF of the motorized tools.
- It includes CENTRAL PRO adaptable to 3PH, oil cooler and double pump.
- Includes an electronic microcontroller: allows software updates at any time.
- Max 1 additional electro-hydraulic function.
- Includes a modular electro-hydraulic system: it allows to increase the number of electro-hydraulic functions.

						
ECO-CUT	cm	cm	m	REF.	REF.	REF.
	60	-	≥ 3,00	ECUT-6-1	ECUT-6-2	-
	80	-	≥ 3,00	ECUT-8-1	ECUT-8-2	-
	60*-60	-	≥ 3,00	-	-	ECUT-66G-4
	60*-80	-	≥ 3,00	-	-	ECUT-68G-4
	80*-60	-	≥ 3,00	-	-	ECUT-86G-4
	80*-80	-	≥ 3,00	-	-	ECUT-88G-4
	80	80	≥ 3,00	-	-	ECUT-88-4
	80	100	≥ 3,00	-	-	ECUT-810-4



*Retractable lawnmower

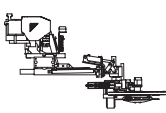

Technical details

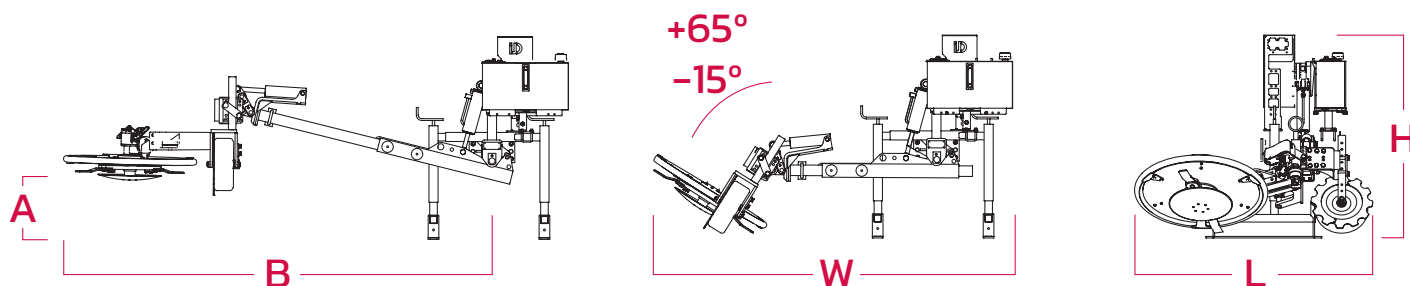
ECO-CUT		REF.	A	B			L	W	H
			m	m	kg	HP	m	m	m
	ECUT-6		0,00-0,50	1,55-2,60	410	50	1,40	2,30	1,30
	ECUT-8		0,00-0,50	1,65-2,70	420	50	1,50	2,40	1,30

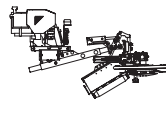

ECO-CUT		REF.	A	B			L	W	H
			m	m	kg	HP	m	m	m
	ECUT-88		0,00-0,50	1,65-2,70	450	50	1,60	2,40	1,30
	ECUT-810		0,00-0,50	1,65-2,70	460	50	1,60	2,40	1,30

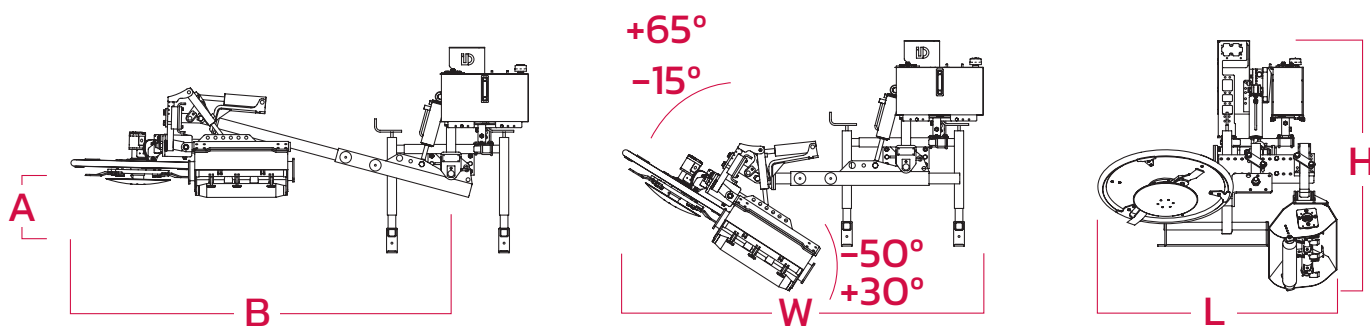

Tractor mounting

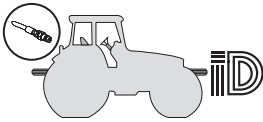
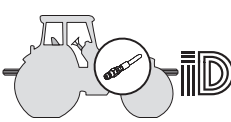

Tractor connection and assembling

	
STANDARD	REF. CMT-20

Chassis

Accessories and Options

	DESCRIPTION	OBSERVATIONS		REF.
	Plate for front tractor coupling	It will be supplied only if the corresponding form has been correctly filled out		PA-F
	3 Points linkage	Front 3P or reversible tractor		T3P-10
	23 Lt Hydraulic power unit type PRO + 27 Lt pump+ oil cooler	-		 CPRO-1
	23 Lt Hydraulic power unit type PRO + 27 Lt pump+ oil cooler Adaptable to 3 PT	Recommended for +4m tractors without front PTO		 CPRO-1-T
	Pressure filter kit + oil cooler	Tractor plugs connection	Intake 12V	KFP-02
	String rotary mower retractable by spring + String spool	Ø600 right	Included as standard: ECUT-6	GSM60H-9-D
		Ø800 Right	Included as standard: ECUT-8, ECUT-88 y ECUT-810	GSM80H-9-D
	Kit for modification of string mower with boron steel blades	Only available for new machine	Right	KSGSH-D
	Kit ID-ROLL Ø600			KEC-R6-D
	Kit ID-ROLL Ø850	Adaptable to frame	Right	KEC-R8-D
	Kit ID STAR 2 discs			KEC-S2-D
	Extra price ID-STAR (3rd disc)	-		 ID-ST23-D
	Plate to combine assembling of ID-ROLL and ID-STAR			PA-RS
	Square string spool	for mower	45 m	BHN-03
	Packaging	Basic		EMB-1
		Airfreight- oceanfreight		EMB-3

Ideal products and services that inspire trust, quality, experience and excellence

Specialized and customized agricultural machines with an attractive design and increasing digitalizations. Our products are oriented towards a biological, environment-friendly and precision farming.



INDUSTRIAS DAVID S.L.U.
C/ Médico Miguel Lucas s/n
CP: 30510, Yecla, Murcia-Spain
Tel.: +34 968 718 119
info@id-david.com

Connect with us.
[instagram.com/iddavid_official](https://www.instagram.com/iddavid_official)
twitter.com/IDdavidslu
[facebook.com/industriasdavid](https://www.facebook.com/industriasdavid)
[linkedin.com/company/id-david](https://www.linkedin.com/company/id-david)
[youtube.com/industriasdavid](https://www.youtube.com/industriasdavid)

www.id-david.com

