

PV-VIEW

EN

Trimmer for vineyards and hedge crops to keep canopy under control

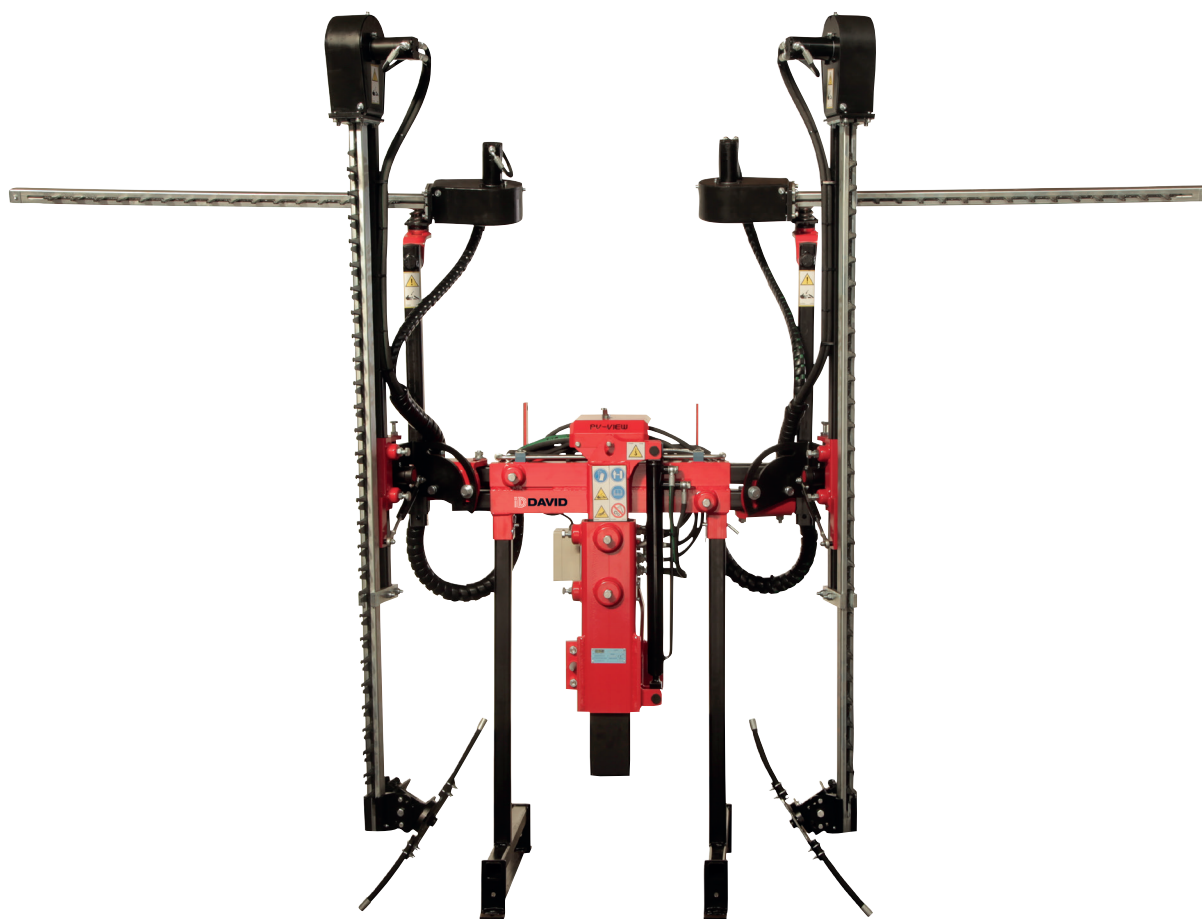

SERIE

PV-VIEW



Trimmer for vineyards and hedge crops to keep canopy under control. High working speeds, clean cut, low maintenance and excellent view from the cab. Available 4 cutter bars and 6 electro-hydraulic functions.

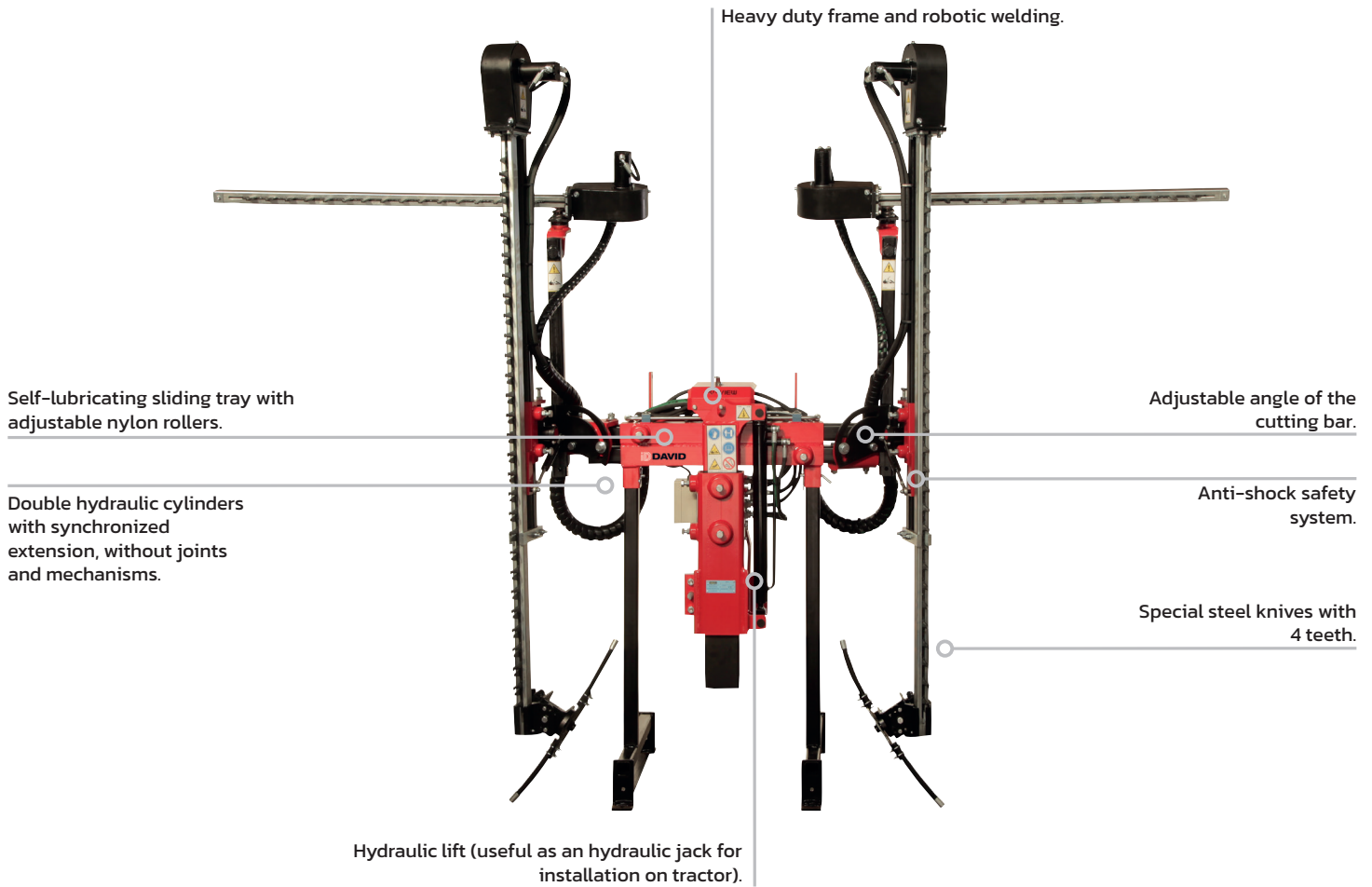

PICTURE MODEL:
PV1775-M + LSN-P

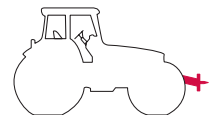

Versatility

- The ID-CONTROL joystick allows to control all the machines manufactured by ID David and equipped with the ID-PLUS or ID-MICRO technology.
- Models adjustable to any kind of plantation system.

Exclusivity

- The crankshaft runs unbalanced moving the blades for a 70% and counter blade for 30% to get a better penetration on the canopy.
- Blades sliding guides made of synthetic material with sliding properties.

Effectiveness

- It allows a working speed up to 12 km/h and a quality cut like "scissors".
- Electrohydraulic system optimized for extremely low power consumption.
- The cut type "scissor" generates less necrosis in certain types of crops compared to the cut by using a disc.

Reliability

- Components and materials of high quality.
- Low maintenance (no needs of lubrication in its key parts).
- Cutting elements supported by years of experience in the market.
- Manufacturing experience since 1975.

Safety

- The strong cutting bars allow green and dry cut.
- Total absence of branches pulled outside compared to the use of rotary knives trimmers.
- Frame with a high vision during work phase.

Sustainability

- An optimal cut improves ventilation and plant health by reducing the use of phytosanitary products.
- The low power required allows the use of small tractors with a lower carbon footprint.
- Sustainable consumption: Equipment designed to be up-to-date and have a long service life.

Standard Equipment

- Anti-shock safety system.
- Sliding tray "no grease" with adjustable nylon wheels.
- Manual adjustment of the angle of incidence.
- Hydraulic lifting.
- Double hydraulic cylinder of synchronized extension.
- Manual cutting bar inclination.
- Reciprocating cutting bars with excentric crankshaft.
- Storage foot.
- Adaptable standard plate to tractor (frontal).
- Lateral support rods.

Remote control type

ID-PLUS

- Includes ID-CONTROL multifunction joystick.
- Includes an electronic microcontroller: allows software updates at any time.
- Includes a modular electro-hydraulic system: it allows to increase the number of electro-hydraulic functions.

ID-MICRO



- ! NOT included the ID-CONTROL multifunction joystick.
- Only for customers who already have the ID-CONTROL multifunction joystick.
- Includes an electronic microcontroller: allows software updates at any time.
- Includes a modular electro-hydraulic system: it allows to increase the number of electro-hydraulic functions.

ID-BASIC

- Includes an electric control box.
- Hydraulic connection to the tractor by 2 hoses.
- ! NOT allowed any updates of electro-hydraulic functions.
- ! NOT allowed extra hydraulic functions..
- ! NOT included the electronic microcontroller.

DIRECT TO TRACTOR

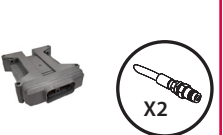

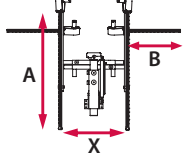
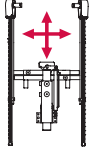
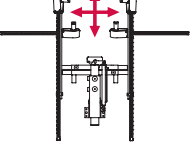
- Includes a pair of hoses with 1/2 male plugs for hydraulic lifting.
- Includes a pair of hoses with 1/2 male plugs for hydraulic extension.
- Includes a pair of hoses with 1/2 male and 3/4 female connectors for ON / OFF.
- ! NOT included the ID-CONTROL multifunction joystick.
- ! NOT included the electronic microcontroller.
- ! NOT allowed extra hydraulic functions.

	 ID-PLUS	 ID-MICRO	 ID-BASIC	 DIRECT TO TRACTOR			
PV-VIEW	REF.	REF.	REF.	REF.	X (m)	A (m)	B (m)
CANE TRIMMER VERTICALS BARS  CUT, LIFT, EXTENSION	PV17-S-1	PV17-S-2	PV17-S-3	PV17-S-5	1,10-2,10	1,75	-
	PV17-M-1	PV17-M-2	PV17-M-3	PV17-M-5	1,50-2,50	1,75	-
	PV20-M-1	PV20-M-2	PV20-M-3	PV20-M-5	1,50-2,50	2,00	-
	PV20-L-1	PV20-L-2	PV20-L-3	PV20-L-5	2,10-3,50	2,00	-
CANE TRIMMER VERTICALS AND HORIZONTALS BARS  CUT, LIFT, EXTENSION	PV1775-S-1	PV1775-S-2	PV1775-S-3	PV1775-S-5	1,10-2,10	1,75	0,75
	PV1775-M-1	PV1775-M-2	PV1775-M-3	PV1775-M-5	1,50-2,50	1,75	0,75
	PV1710-M-1	PV1710-M-2	PV1710-M-3	PV1710-M-5	1,50-2,50	1,75	1,00
	PV2075-M-1	PV2075-M-2	PV2075-M-3	PV2075-M-5	1,50-2,50	2,00	0,75
	PV2010-L-1	PV2010-L-2	PV2010-L-3	PV2010-L-5	2,10-3,50	2,00	1,00

PV-VIEW

Pre-pruning, pruning and leaf stripping

Technical details

PV-VIEW		X	A	B			L	W	H
REF.		m	m	m	kg	HP	m	m	m
VERTICALS BARS	PV17-S	1,10-2,10	1,75	-	270	40	1,20	0,95	2,30
	PV17-M	1,50-2,50	1,75	-	290	40	1,60	0,95	2,30
	PV20-M	1,50-2,50	2,00	-	300	50	1,60	0,95	2,55
	PV20-L	2,10-3,50	2,00	-	340	50	2,60	0,95	2,55
VERTICALS AND HORIZONTALS BARS	PV1775-S	1,10-2,10	1,75	0,75	350	50	1,60	0,95	2,30
	PV1775-M	1,50-2,50	1,75	0,75	370	50	1,90	0,95	2,30
	PV1710-M	1,50-2,50	1,75	1,00	385	50	1,90	0,95	2,30
	PV2075-M	1,50-2,50	2,00	0,75	385	50	1,90	0,95	2,55
	PV2010-L	2,10-3,50	2,00	1,00	395	50	2,90	0,95	2,55

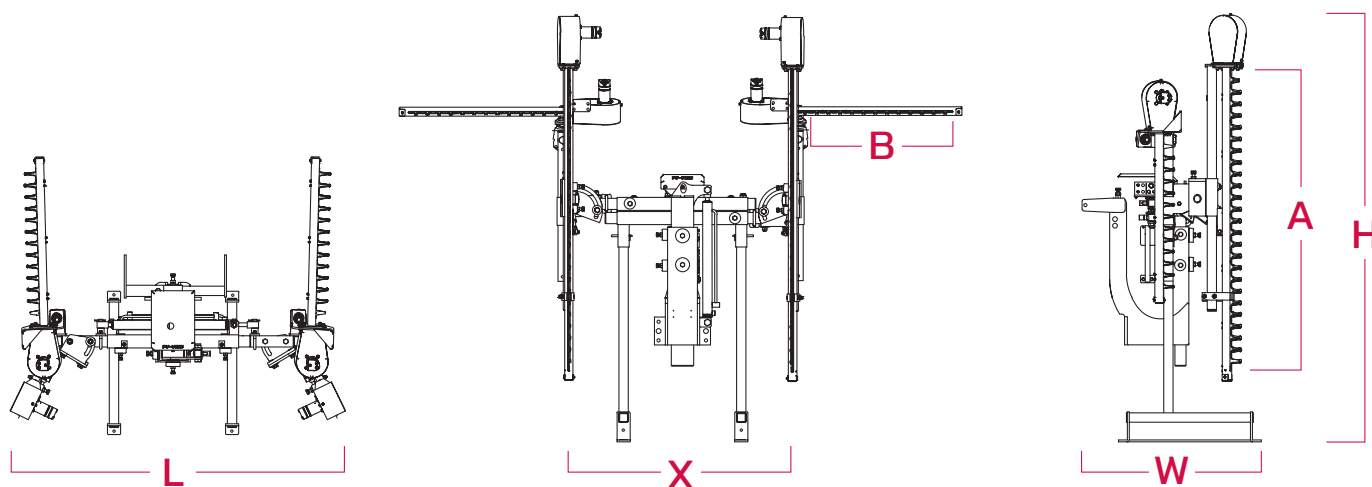

Basic kit to be adapted to new equipments - option

Recommended kit to use on slopes - option



OBSERVATIONS

REF.

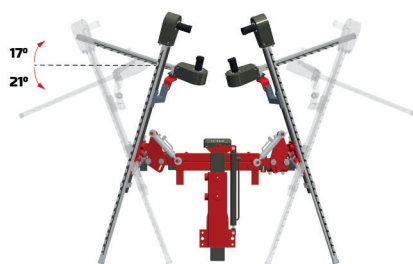

Simultaneous vertical and horizontal tilting bars for using on hills.

available for ID-PLUS and ID-MICRO

POR-1

Simultaneous hydraulic tilting of vertical bars and horizontal to work on slopes. Automated by means of inclinometers.

available for ID-PLUS and ID-MICRO

POR-17

Recommended kit to use on terraces - option



OBSERVATIONS

REF.

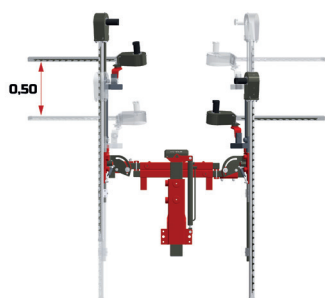

Simultaneous hydraulic lifting of horizontal and vertical bars for using on terraces.

available for ID-PLUS and ID-MICRO

POR-2

Recommended kit for combined use on smart trees and trellis vineyard system



OBSERVATIONS

REF.

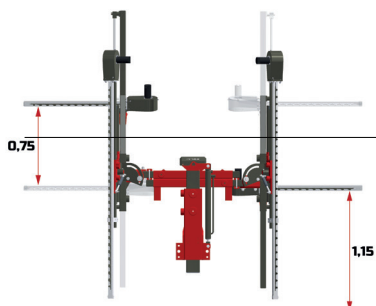

Hydraulic lifting horizontal bar for tree and espalier vineyard.

available for ID-PLUS and ID-MICRO

POR-3

Kit PRO - option



OBSERVATIONS

REF.

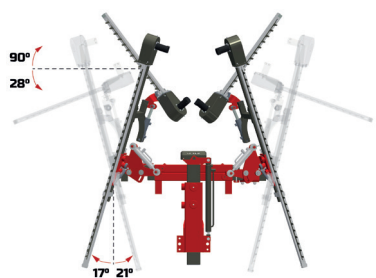

Independent hydraulic tilting of vertical and horizontal bars for working on slopes.

available for ID-PLUS and ID-MICRO

POR-4





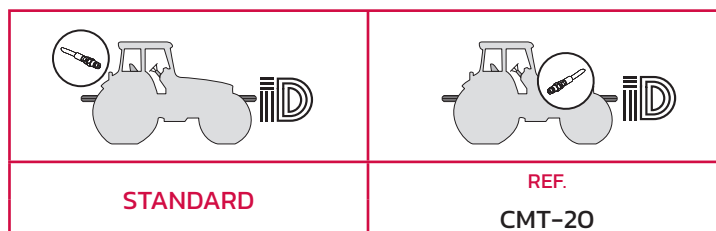

Tractor mounting







Tractor connection and assembling

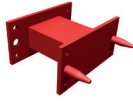

Cane trimmer Accessories and Options

	DESCRIPTION	OBSERVATIONS		REF.
	Hydraulic power unit 60 L to 3 Point linkage	Pump 35 liters		C12
	Standard oil cooler	Adaptable to 60 lt hydraulic power plant		A15-60
	Reciprocating pair of horizontal cutting bars with blades	Included as standard in 4 bars cutting model	0,75 m + 0,75 m	2MH-75
			1 m + 1 m	2MH-10
	Protective screen of the blades PV		Bar 0,75 m	PC-01
			Bar 1,00 m	PC-02
			Bar 1,75 m	PC-03
			Bar 2,00 m	PC-04
	Hydraulic lower vine shoot lifter	Tilting Adjustable	Pair	LSN-P
	3-point coupling kit	Front 3P or reversible tractor		T2P-10
	Plate for front tractor coupling	It will be supplied only if the corresponding form has been correctly filled out		PA-F

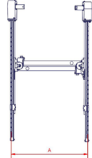
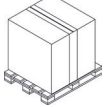
	DESCRIPTION	OBSERVATIONS	REF.
	<p>Special horizontal cutting bar support for V-shape tree vineyards</p>	<p>Includes hardware for coupling to machine</p>	<p>SBCH-P</p>
	<p>Storage Wheel Kit</p>		<p>KRA</p>
	<p>Extensiones L Incrementa la anchura de trabajo (*A) en 400 mm</p> <p>Replace standard extensions</p>	<p>Only for M models</p>	<p></p> <p>KIT-TL</p>
	<p>Packaging</p>	<p>Basic</p> <hr/> <p>Airfreight- oceanfreight</p>	<p>EMB-1</p> <hr/> <p>EMB-2</p>

Our 3-keys Ideology Organizational culture

We focused on Lean Manufacturing philosophy to improve operations management, products and workspaces

The Agile Methodology provides us a way to develop better projects in a faster manner, involving and organizing staff to operate as a whole

Design is our attitude and Design Thinking is the tool to face challenges and solve problems, designing products and services focused on users, involving them in the creative process

Mindset
ID



INDUSTRIAS DAVID S.L.U.
C/ Médico Miguel Lucas s/n
CP: 30510, Yecla, Murcia-Spain
Tel.: +34 968 718 119
info@id-david.com

Connect with us.
[instagram.com/iddavid_official](https://www.instagram.com/iddavid_official)
twitter.com/IDdavidslu
[facebook.com/industriasdavid](https://www.facebook.com/industriasdavid)
[linkedin.com/company/id-david](https://www.linkedin.com/company/id-david)
[youtube.com/industriasdavid](https://www.youtube.com/industriasdavid)

www.id-david.com

