

BASIC-L

EN

Light pre-pruner to use in espalier vineyard



SERIE

BASIC-L



Light pre-pruner to use in espalier vineyard. Optimal for cutting and eliminate the branches between wires.
Cutting head opens by using the joystick.

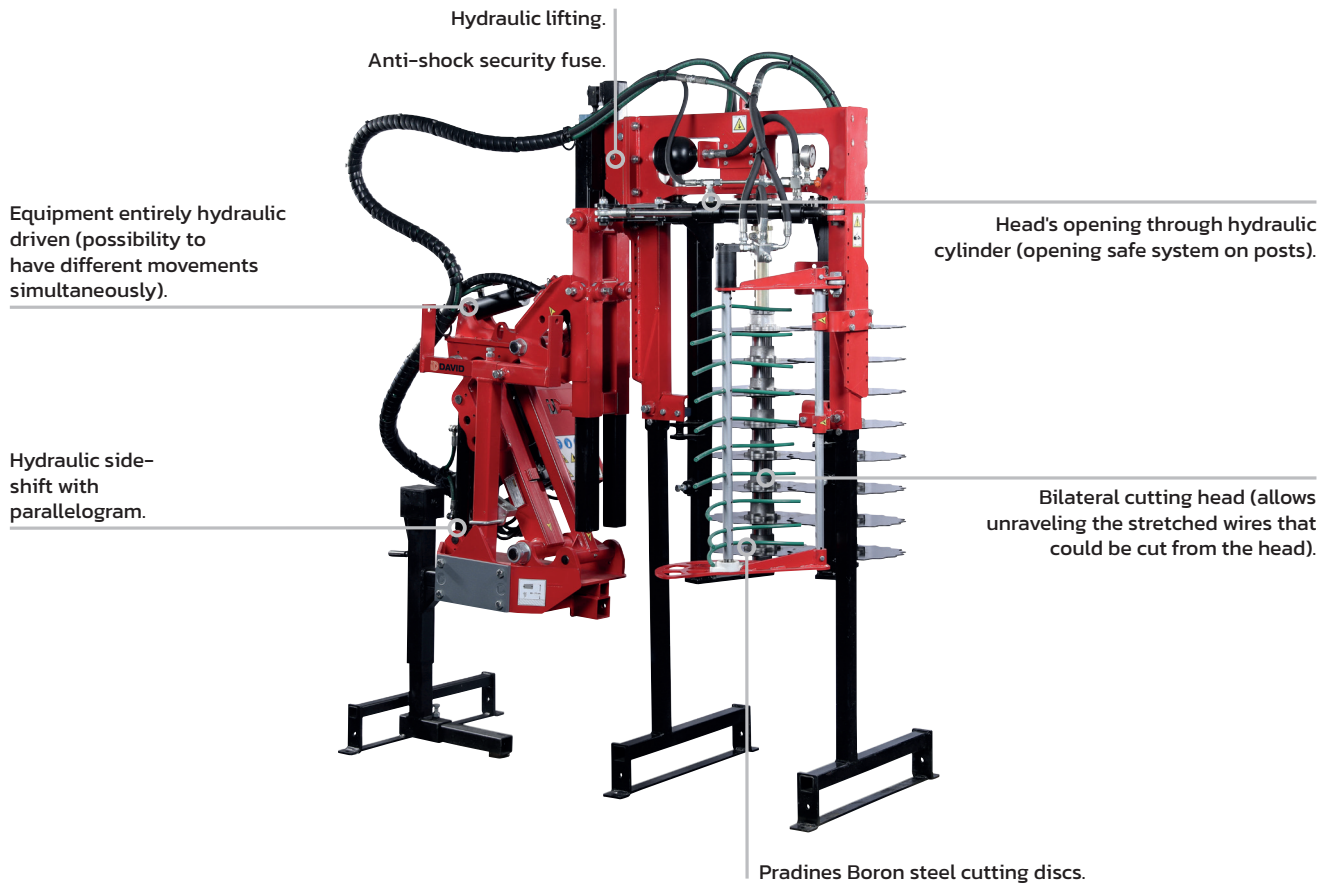

PICTURE MODEL:
BASIC-L8 + LZH-4

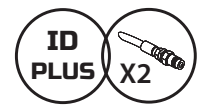
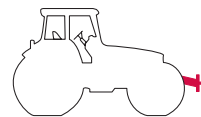

Versatility

- The ID-CONTROL joystick allows to control all the machines manufactured by ID David and equipped with the ID-PLUS or ID-MICRO technology.
- Supports up to 1 meter cutting height, it guarantees a good work in any type of espalier vineyard.

Reliability

- Components and materials of high quality.
- Low maintenance.
- Manufacturing experience since 1980.

Exclusivity

- Patented system of automatic pole detection (optional).
- The particular shape of the discs prevents wire breakage.

Safety

- The front tractor assembly offers optimal vision. The low weight allows the assembly on the centre of tractors starting from 60 HP with the opportunity to drive in reduced areas.
- Easy opening and closing adjustment of the discs to guarantee a good cut safeguarding the posts at the same time.

Effectiveness

- Electrohydraulic system optimized for extremely low power consumption.
- Boron steel cutting elements supported by years of experience in the market.

Sustainability

- Our painting is lead-free and without toxic pigments.
- The low power required allows the use of small tractors with a lower carbon footprint.

Standard Equipment

- Anti-shock security fuse.
- Regulation disc rotation speed.
- Hydraulic lifting.
- Hydraulic parallelogram lateral displacement.
- Opening of cutting head by an oleopneumatic cylinder.
- Cutting head hydraulic inclination.
- Boron steel cutting discs.
- Storage foot.
- Adaptable standard plate to tractor (frontal).
- Lateral support rods.



Remote control type

ID-PLUS

- Includes ID-CONTROL multifunction joystick.
- Includes an electronic microcontroller: allows software updates at any time.
- Up to 2 additional electro-hydraulic functions.
- Includes a modular electro-hydraulic system: it allows to increase the number of electro-hydraulic functions

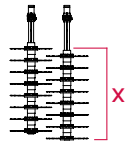

ID-MICRO

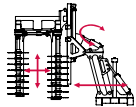
- ! NOT included the ID-CONTROL multifunction joystick.
- Only for customers who already have the ID-CONTROL multifunction joystick.
- Includes an electronic microcontroller: allows software updates at any time.
- Up to 2 additional electro-hydraulic functions.
- Includes a modular electro-hydraulic system: it allows to increase the number of electro-hydraulic functions.

		ID-PLUS 	ID-MICRO 	
BASIC-L	PAIR OF DISCS	X (m)	REF.	REF.
 CUTTING, OPENING, LIFTING, SIDE DEPLACEMENT BY PARALLELOGRAM, HEAD TILTING	5	0,50	BASIC-L5-1	BASIC-L5-2
	6	0,60	BASIC-L6-1	BASIC-L6-2
	7	0,70	BASIC-L7-1	BASIC-L7-2
	8	0,80	BASIC-L8-1	BASIC-L8-2
	9	0,90	BASIC-L9-1	BASIC-L9-2
	10	1,00	BASIC-L10-1	BASIC-L10-2



Technical details

BASIC-L		X	Y			L	W	H
REF.		m	m	kg	HP	m	m	m
LIGHT "BASIC" PREPRUNER	BASIC-L-5	0,50	0,90-1,75	450	60	2,05	0,85	2,30
	BASIC-L-6	0,60	0,90-1,75	460	60	2,05	0,85	2,30
	BASIC-L-7	0,70	0,90-1,75	470	60	2,05	0,85	2,30
	BASIC-L-8	0,80	0,90-1,75	480	60	2,05	0,85	2,30
	BASIC-L-9	0,90	0,90-1,75	490	60	2,05	0,85	2,30
	BASIC-L-10	1,00	0,90-1,75	500	60	2,05	0,85	2,30

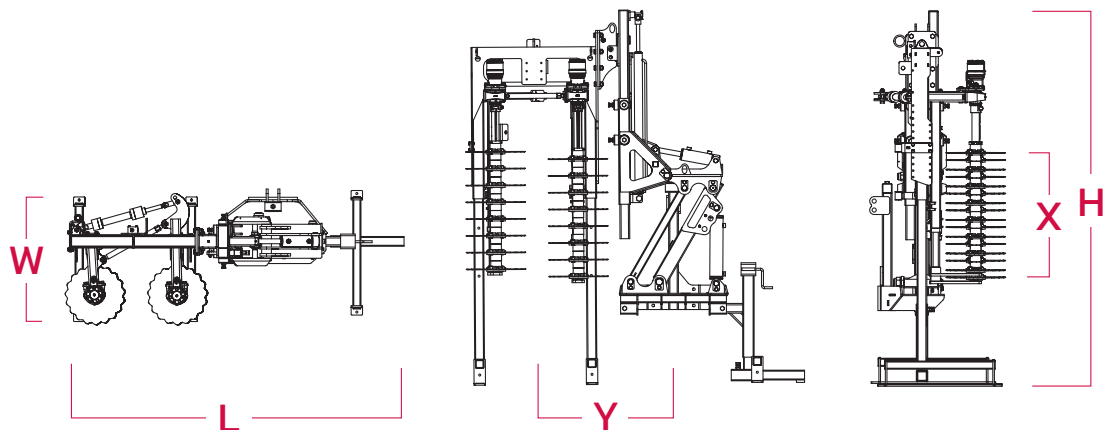





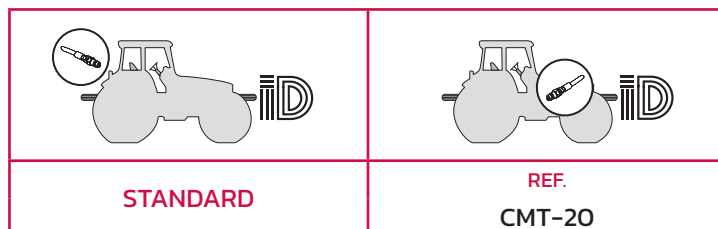

Tractor mounting



Tractor connection and assembling

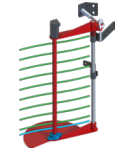

Prepruner Accessories and Options

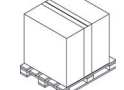
	DESCRIPTION	OBSERVATIONS		REF.
	Hydraulic power unit 60 L to 3 Point linkage	Pump 45 liters	Standard cooler	C11
	Pair of smooth discs			PDP
	Special separator short separator casing	Reduce the distances between discs 5cm		CSC-05
	Hydraulic tendril cleaner	Directly to the tractor		LZH-1
		Serie with motors		LZH-4
		Operable with ON-OFF placed on joystick		LZH-5
	3-point coupling kit	Front 3P or reversible tractor		T2P-10
	Plate for front tractor coupling	It will be supplied only if the corresponding form has been correctly filled out		PA-F
	Packaging	Basic		EMB-1
		Airfreight- oceanfreight		EMB-2

Our 3-keys Ideology Organizational culture

We focused on Lean Manufacturing philosophy to improve operations management, products and workspaces

The Agile Methodology provides us a way to develop better projects in a faster manner, involving and organizing staff to operate as a whole

Design is our attitude and Design Thinking is the tool to face challenges and solve problems, designing products and services focused on users, involving them in the creative process

Mindset
ID



INDUSTRIAS DAVID S.L.U.
C/ Médico Miguel Lucas s/n
CP: 30510, Yecla, Murcia-Spain
Tel.: +34 968 718 119
info@id-david.com

Connect with us.
[instagram.com/iddavid_official](https://www.instagram.com/iddavid_official)
twitter.com/IDdavidslu
[facebook.com/industriasdavid](https://www.facebook.com/industriasdavid)
[linkedin.com/company/id-david](https://www.linkedin.com/company/id-david)
[youtube.com/industriasdavid](https://www.youtube.com/industriasdavid)

www.id-david.com

