

# PV-SETO

EN

*"Inverted L" type reciprocating blades  
pruning equipment for fruit trees*



SERIE

# PV-SETO



"Inverted L" type reciprocating blades pruning equipment for fruit trees. Designed for simultaneous pruning of the sides and top of fruit trees, olive trees and almond trees formed in a hedge. Clean cut, low maintenance and excellent vision from the tractor cab.

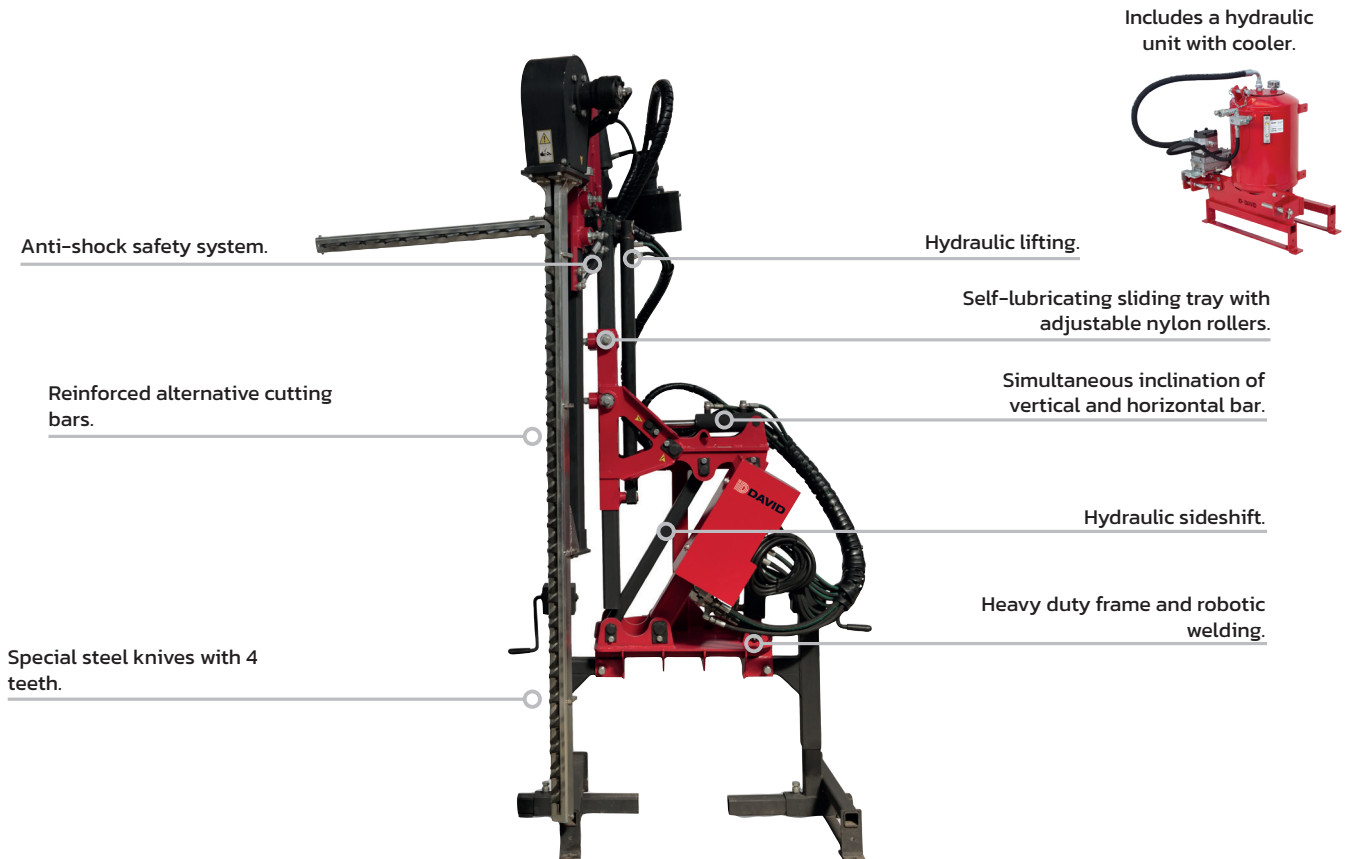

PICTURE MODEL:  
PFL-2010



## Versatility

- The ID-CONTROL joystick allows to control all the machines manufactured by ID David and equipped with the ID-PLUS or ID-MICRO technology.
- Models adaptable to all hedgerow system.

## Exclusivity

- The strong cutting bars allow green and dry cut.
- Blades sliding guides made of synthetic material with sliding properties.

## Effectiveness

- Electrohydraulic system optimized for extremely low power consumption.
- The cut type "scissor" generates less necrosis in certain types of crops compared to the cut by using a disc.

## Reliability

- Low maintenance. No lubrication in its essential parts.
- Cutting elements supported by years of experience in the market.
- Manufacturing experience since 2004.

## Safety

- Total absence of branches pulled outside compared to the use of rotary knives trimmers.
- Frame with a high vision during work phase.

## Sustainability

- The low power required allows the use of small tractors with a lower carbon footprint.
- Sustainable consumption: Equipment designed to be up-to-date and have a long service life.

## Standard Equipment

- Anti-shock safety system.
- Sliding tray "no grease" with adjustable nylon wheels.
- Hydraulic lifting.
- Hydraulic inclination.
- Hydraulic parallelogram lateral displacement.
- Reciprocating cutting bars with excentric crankshaft.
- Hydraulic Power unit with oil cooler.
- Storage foot.
- Adaptable standard plate to tractor (frontal).
- Lateral support rods.



## Remote control type

### ID-PLUS



- Includes ID-CONTROL multifunction joystick.
- Includes an electronic microcontroller: allows software updates at any time.
- Up to 2 additional electro-hydraulic functions.
- Includes a modular electro-hydraulic system: it allows to increase the number of electro-hydraulic functions.

### ID-MICRO

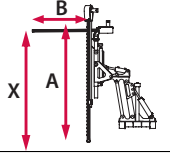
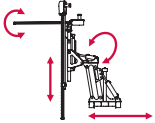
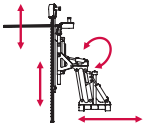
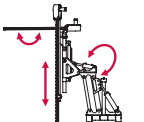
- ! NOT included the ID-CONTROL multifunction joystick.
- Only for customers who already have the ID-CONTROL multifunction joystick.
- Includes an electronic microcontroller: allows software updates at any time.
- Up to 2 additional electro-hydraulic functions.
- Includes a modular electro-hydraulic system: it allows to increase the number of electro-hydraulic functions.

	ID-PLUS 	ID-MICRO 			
<b>PV-SETO</b>	REF.	REF.	A (m)	B (m)	X (m)
 <p>CUT, DISPLACEMENT, MODULE TILT, MODULE LIFT, CUTTING BAR TILT</p>	PFL-2010-1	PFL-2010-2	2,00	1,00	2,20-3,30
	PFL-2510-1	PFL-2510-2	2,50	1,00	
 <p>CUT, DISPLACEMENT, MODULE TILT, MODULE LIFT, HORIZONTAL BAR LIFT</p>	PFF-2010-1	PFF-2010-2	2,00	1,00	1,30-3,30
	PFF-2510-1	PFF-2510-2	2,50	1,00	
 <p>CUT, DISPLACEMENT, MODULE TILT, LIFT MODULE, RETRACTION CUTTING BAR</p>	PVF-2010-1	PVF-2010-2	2,00	1,00	2,20-2,80
	PVF-2510-1	PVF-2510-2	2,50	1,00	

## Technical details

REF.	X	Y	Z	A	B			L	W	H
	m	m	m	m	m	kg	HP	m	m	m
<b>PV-SETO</b> PFL-2010	2,20-3,30	0,45-1,30	1,40-2,20	2,00	1,00	465	60	1,10	1,00	2,60
PFL-2510	2,20-3,30	0,45-1,30	1,40-2,20	2,50	1,00	495	60	1,10	1,00	3,10
PFF-2010	1,30-3,30	0,45-1,30	1,40-2,20	2,00	1,00	480	60	1,10	1,00	2,60
PFF-2510	1,30-3,30	0,45-1,30	1,40-2,20	2,50	1,00	510	60	1,10	1,00	3,10
PVF-2010	2,20-2,80	0,45-1,30	1,40-2,20	2,00	1,00	480	60	1,10	1,00	2,60
PVF-2510	2,20-2,80	0,45-1,30	1,40-2,20	2,50	1,00	510	60	1,10	1,00	3,10

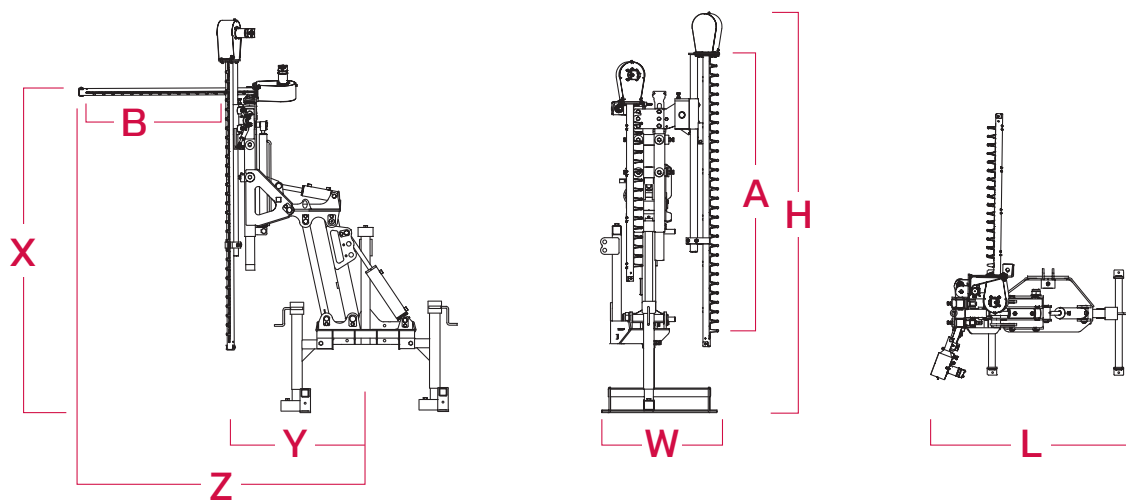



## Tractor mounting

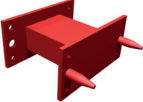

## Cane trimmer

### Accessories and Options

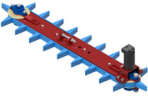
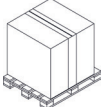
📷	DESCRIPTION	OBSERVATIONS		REF.
	Plate for front tractor coupling	It will be supplied only if the corresponding form has been correctly filled out		PA-F
	3-point coupling kit	Front 3P or reversible tractor		T2P-10
	Kit hydraulic branch extractors	Bar of 1000	Right	KEX-02-D
	Packaging	Basic		EMB-1
		Airfreight- oceanfreight		EMB-3



## Inherent in our DNA

We use technology to create technology.  
Our commitment to the digitization and versatility of our equipment has led to the creation of our exclusive ID PLUS system which allows the control of all ID machines through a simple Plug & Play Joystick.



**INDUSTRIAS DAVID S.L.U.**  
C/ Médico Miguel Lucas s/n  
CP: 30510, Yecla, Murcia-Spain  
Tel.: +34 968 718 119  
[info@id-david.com](mailto:info@id-david.com)

**Connect with us.**  
[instagram.com/iddavid\\_official](https://www.instagram.com/iddavid_official)  
[twitter.com/IDdavidslu](https://twitter.com/IDdavidslu)  
[facebook.com/industriasdavid](https://www.facebook.com/industriasdavid)  
[linkedin.com/company/id-david](https://www.linkedin.com/company/id-david)  
[youtube.com/industriasdavid](https://www.youtube.com/industriasdavid)

[www.id-david.com](http://www.id-david.com)

