

TRIM-PRO

EN

Hedges disc pruner

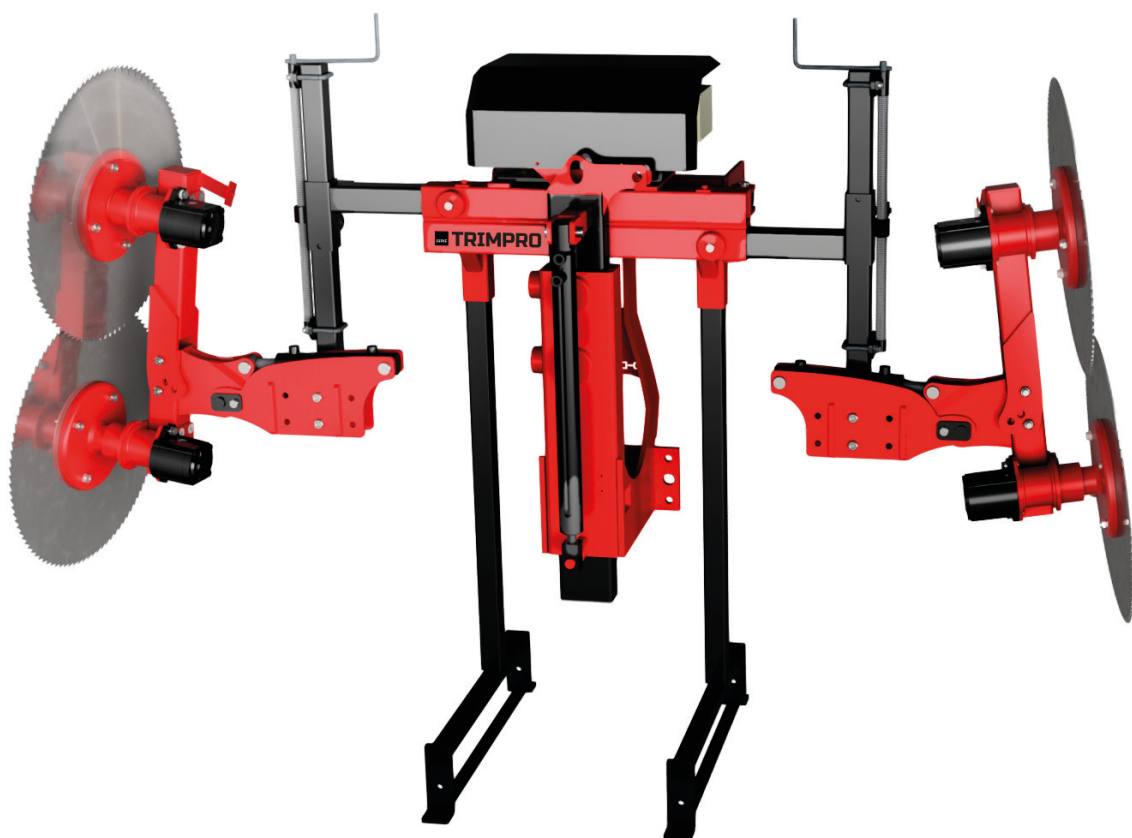

TRIM-PRO



Hedges disc pruner. Suitable for lateral and topping pruning in berries, agave and hedge crops formed in rows to maintain the morphology of the vegetative growth.

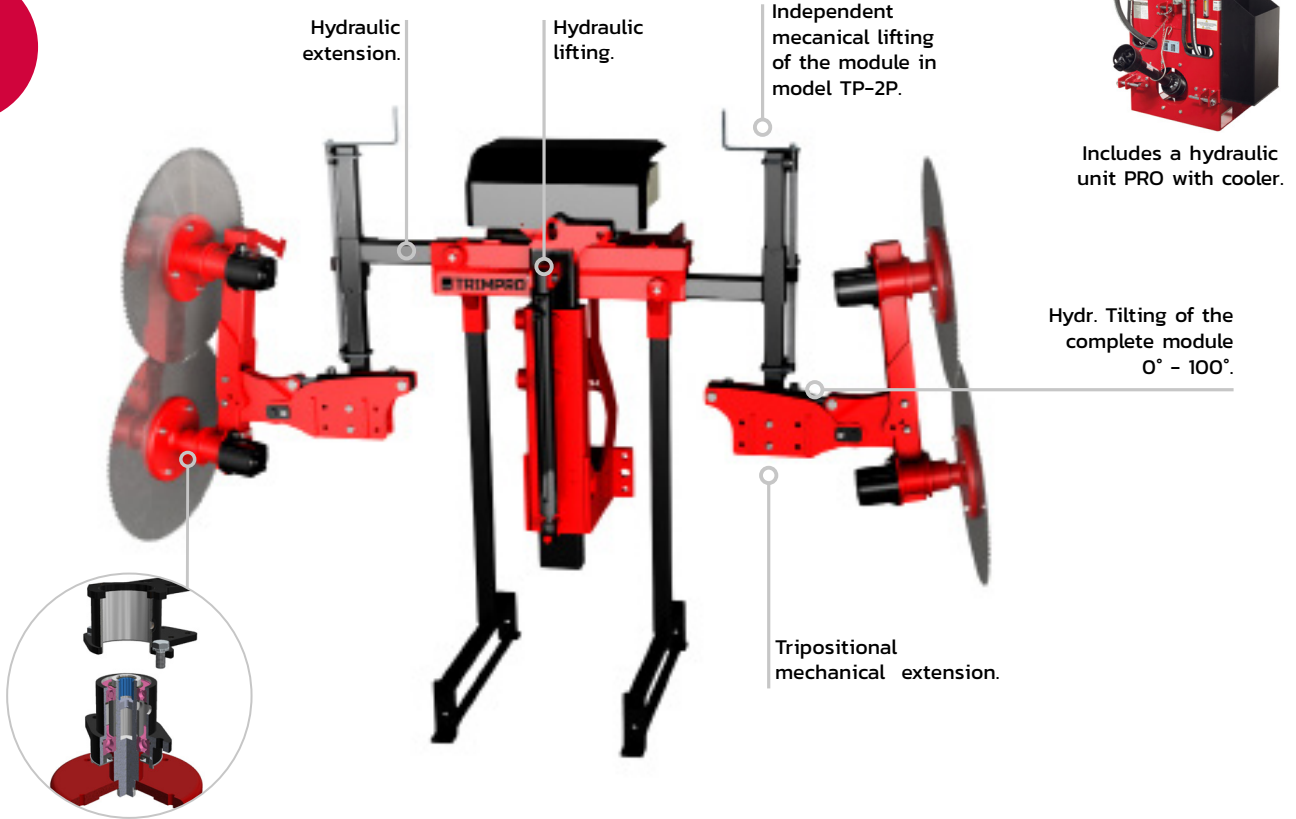

Powered by **SKF**
Maintenance free hub.

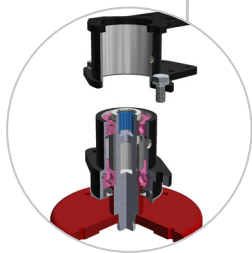

PICTURE MODEL:
TP-2P

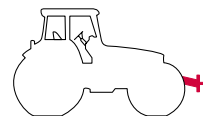

Versatility

- Different models of discs to guarantee quality and cutting power adapted to each type and intensity of pruning.
- The ID-CONTROL joystick allows to control all the machines manufactured by ID David and equipped with the ID-PLUS.
- Models adjustable to any kind of plantation system.

Exclusivity

- The first and unique range of pruners in the world equipping each disc with independent hydraulic motors since 2001.
- Electronic indication for RPM of cutting disc (optional).

Effectiveness

- Electrohydraulic system optimized for extremely low power consumption.
- Correct evacuation of the remains of the pruning.
- High cutting capacity up to 20 cm.

Reliability

- Components and materials of high quality.
- Low maintenance. No lubrication in its essential parts.
- Manufacturing experience since 1983.

Safety

- Anti-shock safety system.
- Motors with safety valve and automatic reset in case of a shut down.
- Great vision during working phase.

Sustainability

- Our painting is lead-free and without toxic pigments.
- The low power required allows the use of small tractors with a lower carbon footprint.
- Sustainable consumption: Equipment designed to be up-to-date and have a long service life.

Standard Equipment

- 1 Motor + safety valve on each disc.
- Hydraulic lifting.
- Hydraulic inclination.
- Hardened steel 86 teeth-disc.
- Progressive starting of motors.
- Safety system with automatic reset.
- Includes a PRO hydraulic unit with cooler and quick couplings.
- Storage foot.
- Adaptable standard plate to tractor (frontal).
- Lateral support rods.



Remote control type

ID-PLUS

- It includes ID-CONTROL multifunction joystick.
- Includes an electronic microcontroller: allows software updates at any time.
- Max 1 additional electro-hydraulic function.
- Includes a modular electro-hydraulic system: it allows to increase the number of electro-hydraulic functions.

ID-MICRO

- ! Not included the ID-CONTROL multifunction joystick.
- Only for customers who already have the ID-CONTROL multifunction joystick.
- Includes an electronic microcontroller: allows software updates at any time.
- Max 1 additional electro-hydraulic function.
- Includes a modular electro-hydraulic system: it allows to increase the number of electro-hydraulic functions.

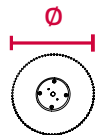
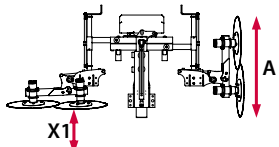
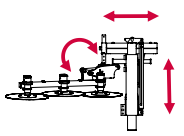
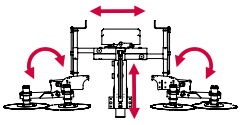
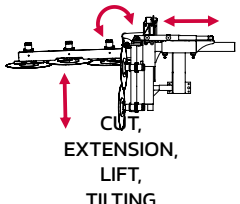

	ID-PLUS 	ID-MICRO 			
TRIM-PRO	REF.	REF.	N° DISCS	A (m)	X1 (m)
	TP-2D-1	TP-2D-2	2 Ø600 mm	1,12	0,85-1,65
	TP-3D-1	TP-3D-2	3 Ø600 mm	1,65	
	TP-2P-1	TP-2P-2	2+2 Ø600 mm	1,12	0,56-1,06
	TP-32D-1	TP-32D-2	3H+2V Ø600 mm	1,65/1,12	0,96-1,46

TRIMPRO

Prepruning, pruning and leaf stripping



Technical details

		X1	X2	Y1	Y2	A			L	W	H
	REF.	m	m	m	m	m	kg	HP	m	m	m
TRIM-PRO	TP-2D	0,70-1,90	0,80-1,80	0,80-1,60	1,20-2,00	1,10	350	70	1,35	1,20	1,85
	TP-3D	0,70-1,90	0,80-1,80	0,80-1,60	1,70-2,50	1,65	370	70	1,35	1,20	2,40
	TP-2P	0,25-1,15	0,75 -1,25	0,75-1,55	2,45-3,75	1,10	480	70	1,80	0,90	1,65
	TP-32D	0,10-0,55	0,50-1,40	0,75-1,25	2,25-2,75	1,65 / 1,10	480	70	3,00	1,25	1,55

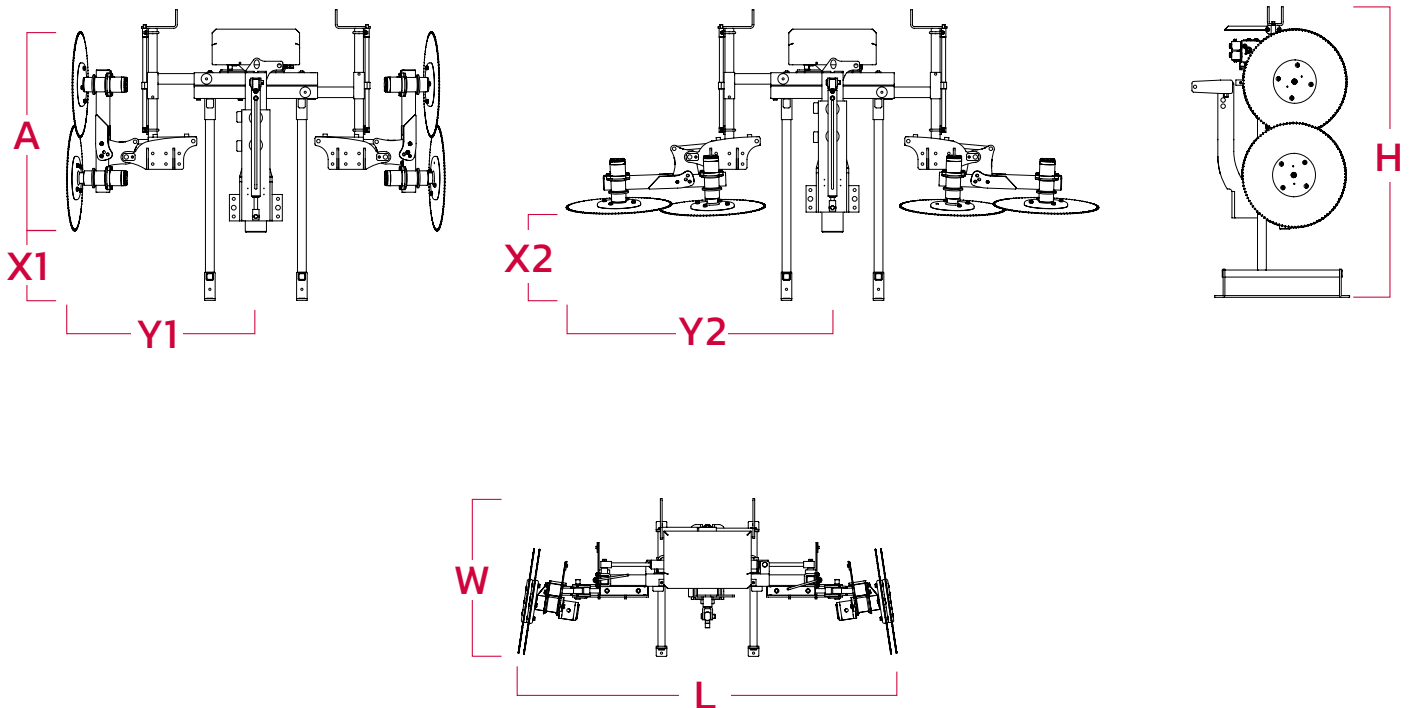



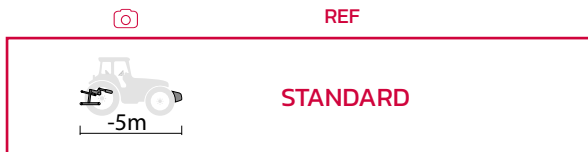









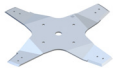



Tractor mounting



Connectivity and telemetry Accessories and Options

	DESCRIPTION	OBSERVATIONS	REF.
  	Visualization and telematics monitoring pack	*Only available for new machine with ID-PLUS PRO hydraulic power pack + oil cooler required	FPRO-05

Prepruner Accessories and Options

	DESCRIPTION	OBSERVATIONS	REF.
	Cutting disc type HOZ: specific for agave		D-Z2H-R
	Knife discs for green branches: ideal for almond trees	Right	D-Z3-D
		Left	D-Z3-I
	Knife discs for green branches with suction system	Right	D-Z4-D
	Knife discs for green branches with suction system	Left	D-Z4-I
	Hardened steel 150 teeth-disc	Thin branches or fibrous materials	D-Z150
	Hardened steel 100 teeth-disc		D-Z100
	Hardened steel 86 teeth-disc	Standard included	D-Z86
	Hardened steel 50 teeth-disc		D-Z50
	DAVISC 40 notched-Disc		DA-Z40
	RPM electronic counter of cutting disc		LD-RPM
	Plate for front tractor coupling	It will be supplied only if the corresponding form has been correctly filled out	PA-F
	3-point coupling kit	Front 3P or reversible tractor	T2P-10
	3 Points linkage	Front 3P or reversible tractor	T3P-15
	Sharpening tool		M-A
	Sharpener disc replacement	For HSS disc and DAVISC disc	D-AA
	Disc protective screen		Unit PD-D6
	Storage Wheel Kit	For hydraulic power plant	KRCH
	Packaging	Basic	EMB-1
		Airfreight- oceanfreight	EMB-3

Inherent in our DNA

We use technology to create technology.
Our commitment to the digitization and versatility of our equipment has led to the creation of our exclusive ID PLUS system which allows the control of all ID machines through a simple Plug & Play Joystick.



INDUSTRIAS DAVID S.L.U.
C/ Médico Miguel Lucas s/n
CP: 30510, Yecla, Murcia-Spain
Tel.: +34 968 718 119
info@id-david.com

Connect with us.
[instagram.com/iddavid_official](https://www.instagram.com/iddavid_official)
twitter.com/IDdavidslu
[facebook.com/industriasdavid](https://www.facebook.com/industriasdavid)
[linkedin.com/company/id-david](https://www.linkedin.com/company/id-david)
[youtube.com/industriasdavid](https://www.youtube.com/industriasdavid)

www.id-david.com

