

RUNDER

IT

Rullo pacciamatore reversibile

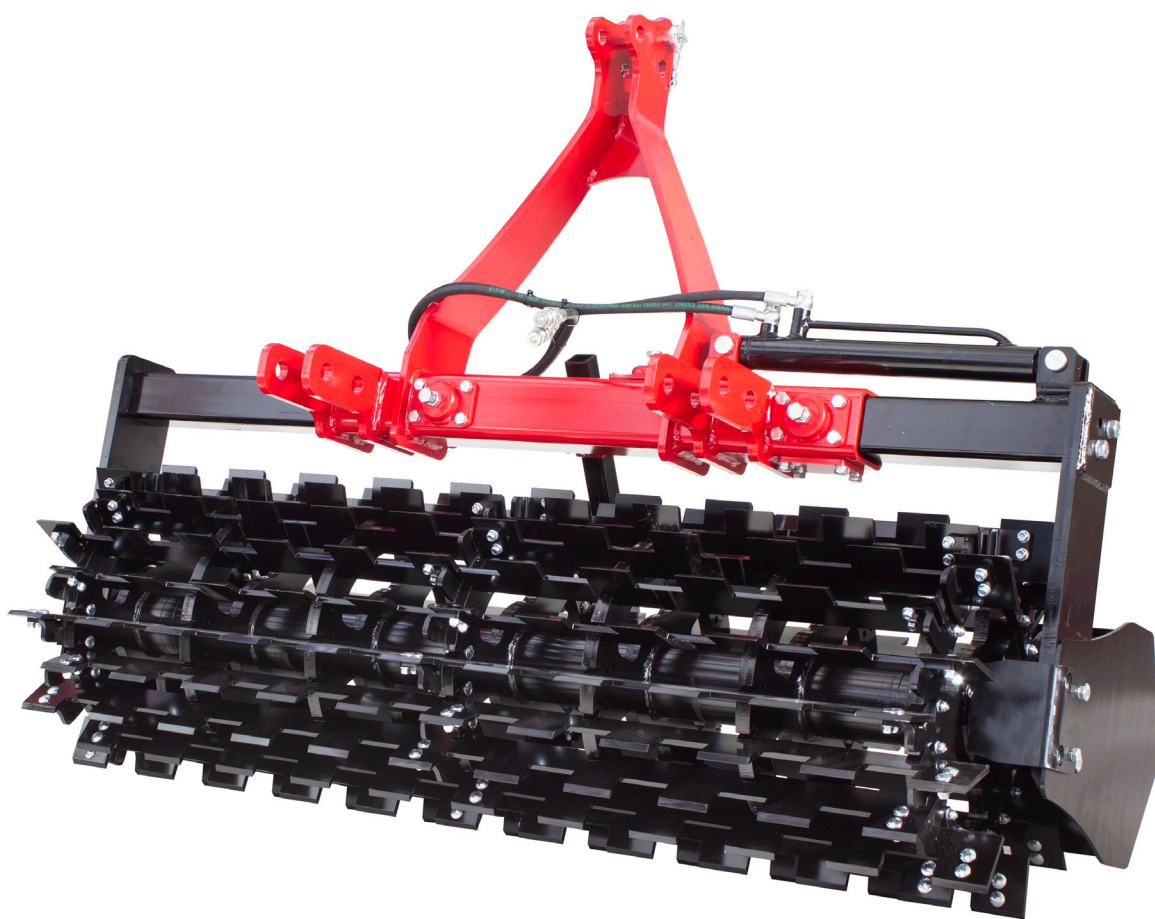

VITI



SETO



ARBO



DAVID
SMART FARMING SOLUTIONS

SERIE

RUNDER



Rullo pacciamatore reversibile. Ideale per piegare l'erba sulle colture di copertura mediante palette, mantenendo viva la copertura e permettendo la ricrescita nella zona di piegatura, generando una coltre di materia organica.

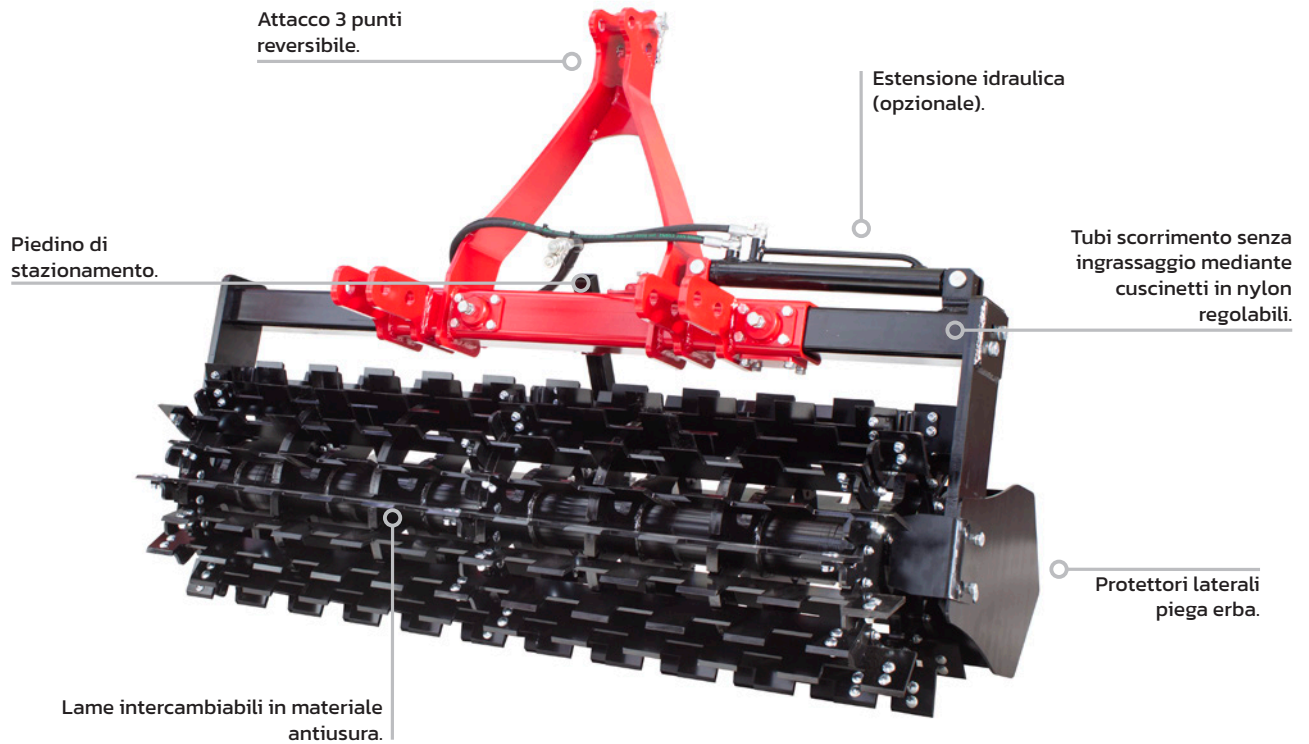

MODELLO IMMAGINE:
BER-M + CD

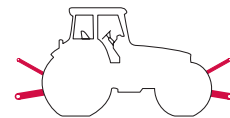

Polivalenza

- Modelli adattabili a qualsiasi tipo di impianto e misura.
- Possibilità di uso combinato con altri attrezzi
- Lavoro eccezionale su qualsiasi tipo di coperta vegetale.

Esclusività

- Possibilità di sostituire le palette con lame a punta per migliorare l'ossigenazione e l'infiltrazioni di acqua.
- Lame intercambiabili.

Efficienza

- Velocità di lavoro fino a 20 km/h.
- Design basato sull'aumento della vita utile dei prodotti e possibilità di aggiornamento costante.

Affidabilità

- Telaio robusto e saldatura robotizzata.
- Componenti e materiali di alta qualità e prime marche.
- Lame intercambiabili in materiale antiusura

Sicurezza

- Tutti i modelli sono progettati per un utilizzo sicuro, semplice e intuitivo.

Sostenibilità

- Alternativa al taglio dell'erba, consente l'utilizzo di trattori con minore potenza e, di conseguenza, la riduzione dell'impronta di carbonio.
- Usiamo vernici senza piombo e pigmenti tossici.



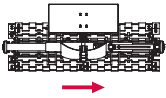
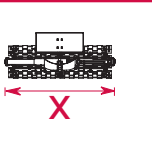
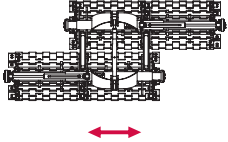

Di serie

- Telaio reversibile per attacco al 3 punto frontale o posteriore.
- Estensioni idrauliche dirette al trattore (modelli HD)
- Rullo Ø500 mm dotato di 20 lame standard intercambiabili.
- Barra aggancio CAT 2.
- Piedino di stazionamento.
- Protezioni antiurto sui cuscinetti.

RUNDER	m	RIF.
	 1,50 1,75 2,00	BER-S BER-M BER-L
HD 	1,50-2,00 1,75-2,40 2,00-2,80 2,15-3,15	BER-HD-S BER-HD-M BER-HD-L BER-HD-XL

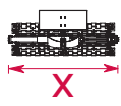

Specifiche Tecniche

					L	W	H	
	RIF.	m	m	kg	HP	m	m	m
RUNDER	BER-S	1,50	750-980	430	50	1,60	0,70	1,20
	BER-M	1,75	875-1195	500	50	1,85	0,70	1,20
	BER-L	2,00	1000-1415	560	50	2,10	0,70	1,20
RUNDER HD	BER-HD-S	1,50-2,00	980-980	860	80	1,60	1,10	1,20
	BER-HD-M	1,75-2,40	1195-1195	1000	80	1,85	1,10	1,20
	BER-HD-L	2,00-2,80	1415-1415	1120	80	2,10	1,10	1,20
	BER-HD-XL	2,15-3,15	1575-1575	1120	80	2,25	1,10	1,20

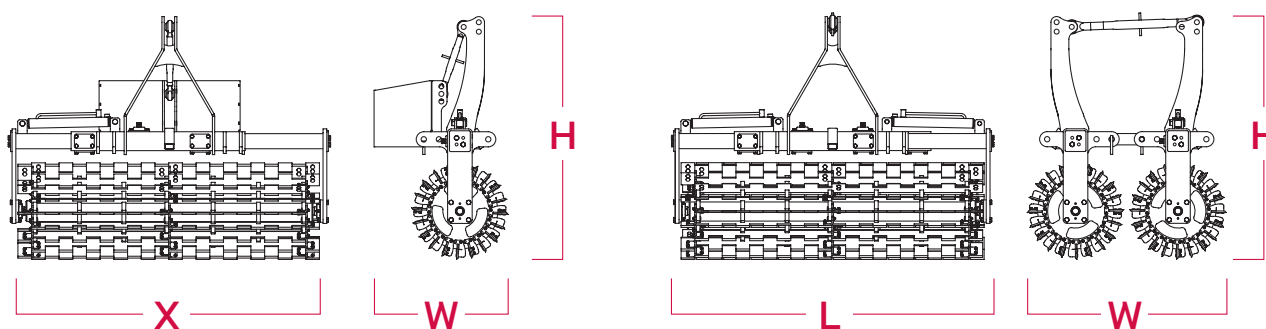

Accoppiamento al trattore





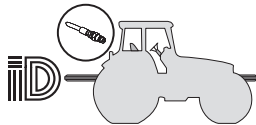
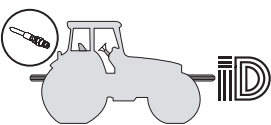
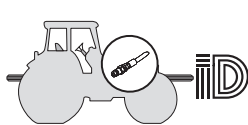

Connessioni e attacco trattore

		
STANDARD	RIF. CMT-10	RIF. CMT-5

Telaio

Accessori ed Opzioni

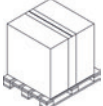
	DESCRIZIONE	OSSERVAZIONI		RIF.
	Kit Lama a punta (20 unità)	BER-S		PP-1
	Kit Lama a punta (20 unità)	BER-M		PP-2
	Kit Lama a punta (20 unità)	BER-L		PP-3
	Kit Lama a punta (40 unità)	BER-HD-S		PP-4
	Kit Lama a punta (40 unità)	BER-HD-M		PP-5
	Kit Lama a punta (40 unità)	BER-HD-L / XL		PP-6
	Cilindro di spostamento	Disponibile per i modelli BER-S / M / L	Attacco diretto trattore 	CD
	Cassa contrappeso	Disponibile per i modelli BER-S / M / L		CP
	Imballaggio macchina	Di base		EMB-1
		Speciale aereo/marittimo		EMB-2

Alleanze strategiche, la nostra chiave per la competitività

Estendere la collaborazione con altre organizzazioni è un punto chiave della nostra strategia per la crescita imprenditoriale. Ci affidiamo alla collaborazione con Università, Politecnici, Centri di Ricerca, Cluster, Associazioni di Imprese ed esperti che arricchiscono le nostre conoscenze ed il nostro Ecosistema.



INDUSTRIAS DAVID S.L.U.
C/ Médico Miguel Lucas s/n
CP: 30510, Yecla, Murcia-Spain
Tel.: +34 968 718 119
info@id-david.com

Connettiti con noi.
[instagram.com/iddavid_official](https://www.instagram.com/iddavid_official)
twitter.com/IDdavidslu
[facebook.com/industriasdavid](https://www.facebook.com/industriasdavid)
[linkedin.com/company/id-david](https://www.linkedin.com/company/id-david)
[youtube.com/industriasdavid](https://www.youtube.com/industriasdavid)

www.id-david.com

