

ID-ROLL

FR

*Châssis réversible avec disque à
doigts et disque emoteurs*



SERIE

ID-ROLL



Châssis réversible avec disque à doigts et disque emoteurs. Parfait pour l'entretien et l'élimination des petites mauvaises herbes entre les plantes formées en rangées.

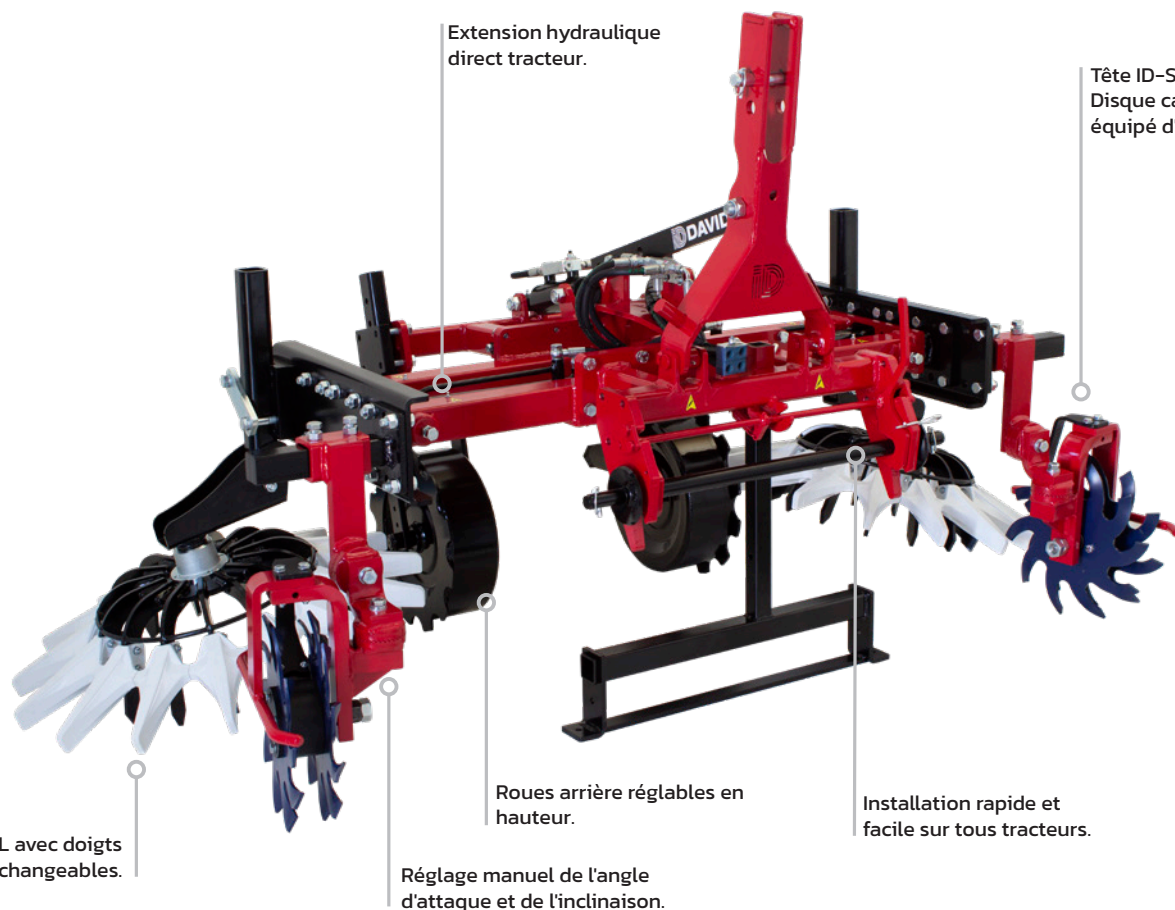

Extension hydraulique direct tracteur.

Tête ID-STAR.
Disque cassant équipé d'un racleur.

Tête ID-ROLL avec doigts interchangeables.

Roues arrière réglables en hauteur.

Installation rapide et facile sur tous tracteurs.

Réglage manuel de l'angle d'attaque et de l'inclinaison.

MODÈLE D'IMAGE:

ROLL-M-P + CRA-DT



Polyvalence

- Gamme complète. Une configuration adaptée à a tous les besoins.

Exclusivité

- Les doigts en caoutchouc peuvent être remplacés individuellement. Différents formats sont disponibles en fonction du type de terrain.

Efficacité

- Vitesses de travail jusqu'à 20 km/h.
- Conception basée sur allongement de la durée de vie utile des produits et la possibilité de les mettre à jour constamment.

Fiabilité

- Châssis à toute épreuve et soudage robotisé.
- Composants et matériaux de haute qualité et premières marques.
- Tête construite en Hardox.

Sécurité









- Tous les modèles sont conçus pour une utilisation sûre, simple et intuitive.
- Protection maximale des plantes à partir de 2 ans.



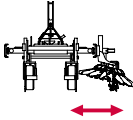

Soutenabilité

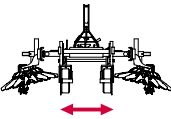
- Alternative écologique à l'utilisation d'herbicides.
- Nous utilisons des peintures sans plomb et sans pigments toxiques.
- Améliore la structure et la porosité du sol.

De série

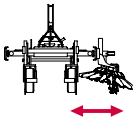
- Chassis réversible sur 3 points arrière ou avant.
- Extension hydraulique direct tracteur.
- Paire de roues métalliques et réglable en largeur et hauteur.
- Pieds de dépose.
- Attelage rapide.
- ID-ROLL équipé de embouts interchangeables.
- ID-STAR 2 ou 3 disques emoteurs (selon model).

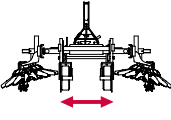
				
ID-ROLL		m	REF. EUROS	REF. EUROS
	DROITE	$\geq 2,00$	ROLL-S2-D	ROLL-S3-D
		$\geq 2,40$	ROLL-M2-D	ROLL-M3-D
		$\geq 2,80$	ROLL-L2-D	ROLL-L3-D
	PAIRE	2,00-2,60	ROLL-S2-P	ROLL-S3-P
		2,60-3,15	ROLL-M2-P	ROLL-M3-P
		3,15-4,05	ROLL-L2-P	ROLL-L3-P

	DROITE	$\geq 1,80$	ROLL-6-S2-D	ROLL-6-S3-D
		$\geq 2,20$	ROLL-6-M2-D	ROLL-6-M3-D
		$\geq 2,60$	ROLL-6-L2-D	ROLL-6-L3-D
	PAIRE	1,80-2,35	ROLL-6-S2-P	ROLL-6-S3-P
		2,35-2,90	ROLL-6-M2-P	ROLL-6-M3-P
		2,90-3,80	ROLL-6-L2-P	ROLL-6-L3-P



Détails techniques

ID-ROLL	REF.	Y			L	W	H	
		m	kg	HP	m	m	m	
	DROITE	ROLL-S-D	≥ 2,00	290	30	1,40	1,20	1,35
		ROLL-M-D	≥ 2,40	300	35	1,40	1,75	1,35
		ROLL-L-D	≥ 2,80	310	40	1,40	2,30	1,35
PAIRE	ROLL-S-P	1,90-2,55	350	35	1,40	1,88	1,35	
	ROLL-M-P	2,50-3,15	365	40	1,40	2,30	1,35	
	ROLL-L-P	3,05-4,05	380	45	1,40	2,84	1,35	

	DROITE	ROLL-6S-D	≥ 1,80	260	30	1,20	1,15	1,35
		ROLL-6M-D	≥ 2,20	270	35	1,20	1,70	1,35
		ROLL-6L-D	≥ 2,60	280	40	1,20	2,25	1,35
PAIRE	ROLL-6S-P	1,70-2,35	320	35	1,20	1,58	1,35	
	ROLL-6M-P	2,25-2,90	335	40	1,20	2,00	1,35	
	ROLL-6L-P	2,80-3,80	350	45	1,20	2,54	1,35	

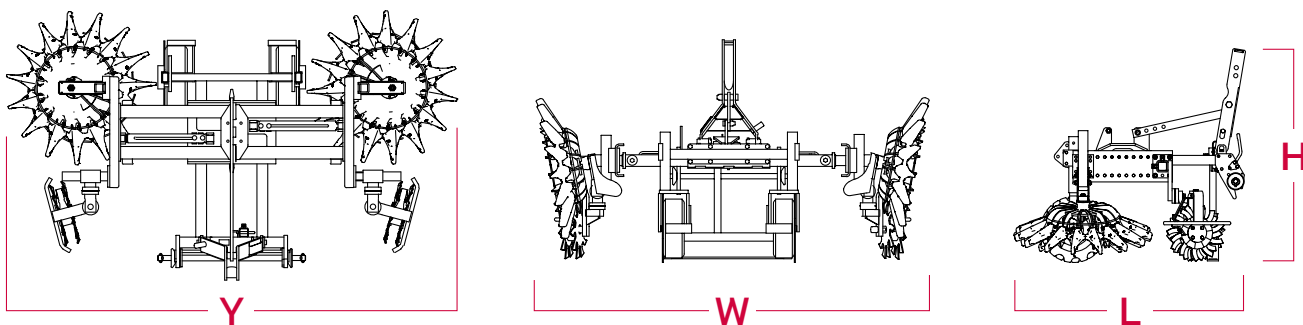

Adaptation au tracteur



Barre d'attelage

S De série
• Optionnel
(Remplace le standard)

ID-ROLL	REF.	Ø22	Ø28	Ø28
		REF. BE-2271	STANDARD	REF. BE-2887
ROLL-S		•	S	•
ROLL-M		•	S	•
ROLL-L		•	S	•



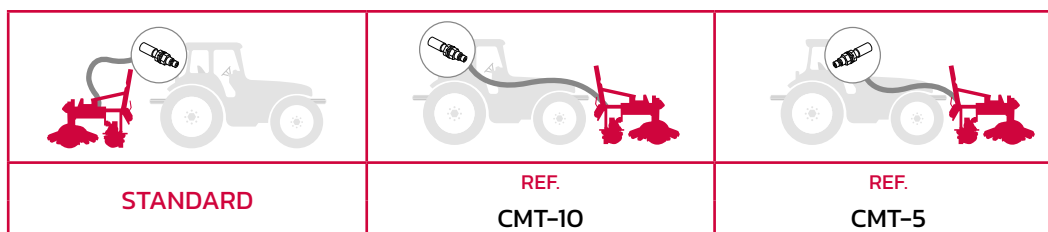







Connexion et attelage tracteur

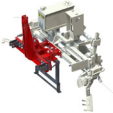

* Attelage troisième point et pièce attelage tracteur pas inclus.

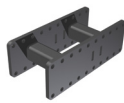
Châssis

Accessoires et Options

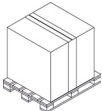
	DESCRIPTION		OBSERVATIONS	REF.
	Réglage hydraulique hauteur du travail		Direct tracteur Nouveau machine	CRA-DT-1
	Troisième point basculant <small>*Remplace le standard (Inclinaison: +10° , -10°)</small>		Nouveau machine	TSB-01
	Inclination hydraulique ID-ROLL <small>*Augmente la largeur de travail de 10 cm Correction : +21° , -10°</small>		Direct tracteur Unité	IH-DT
	ID-STAR 2 disques émotteurs			ID-ST2-D
	ID-STAR 3 disques émotteurs	Droite		ID-ST3-D
	Prix supplémentaire ID-STAR (3eme disque)			ID-ST23-D
	ID-STAR 2 disques émotteurs			ID-ST2-P
	ID-STAR 3 disques émotteurs	Paire		ID-ST3-P
	Prix supplémentaire ID-STAR (3eme disque)			ID-ST23-P
	Surextension plaque complète	120 mm		SEC-12
		200 mm		SEC-20
	Charrue 2 disques (sans moteur) pour chausser	Ø16" Largeur de travail maxi 400mm	Droite	ADCV2D
	Charrue 2 disques (sans moteur) pour chausser		Paire	ADCV2P
	Charrue 3 disques (sans moteur) pour chausser	Ø16" Largeur de travail maxi 550mm	Droite	ADCV3D
	Charrue 3 disques (sans moteur) pour chausser		Paire	ADCV3P
	Kit ID-ROLL Ø600	Droite		KCAB-R6-D
	Kit ID-ROLL Ø850			KCAB-R8-D
	Kit ID-ROLL Ø600	Paire		KCAB-R6-P
	Kit ID-ROLL Ø850			KCAB-R8-P
	Kit de rétrécissement ID-ROLL	ÉTROIT 13.5cm	Droite	KEROLL-D
		ÉTROIT 27cm	Paire	KEROLL-P
	Emballage machine	Basique		EMB-1
		Special avion/maritime		EMB-3



Produits et services idéaux, qui transmettent la confiance, la qualité, l'expérience et l'excellence

Machines agricoles personnalisées, spécialisées, de conception exceptionnelle et, de plus en plus, digitalisées. Nos produits sont orientés vers une agriculture de précision, écologique et respectueuse de l'environnement.



INDUSTRIAS DAVID S.L.U.
C/ Médico Miguel Lucas s/n
CP: 30510, Yecla, Murcia-Spain
Tel.: +34 968 718 119
info@id-david.com

Connectez-vous avec nous.
[instagram.com/iddavid_official](https://www.instagram.com/iddavid_official)
twitter.com/IDdavidslu
[facebook.com/industriasdavid](https://www.facebook.com/industriasdavid)
[linkedin.com/company/id-david](https://www.linkedin.com/company/id-david)
[youtube.com/industriasdavid](https://www.youtube.com/industriasdavid)

www.id-david.com

